



**schoolfurn**

*Furnishing the Future!*

📞 1300 800 957

✉️ sales@schoolfurn.com.au

🌐 www.schoolfurn.com.au



# WINTER 2022 PRODUCT CATALOGUE

TABLES | SEATING | OUTDOOR | STORAGE | DISPLAY | OFFICE





For over 20 years, Schoolfurn has been a leading supplier of school and office furniture. At Schoolfurn, we're passionate about creating engaging learning spaces that are student-focused, flexible and affordable. By providing design services, transparent pricing and Australia wide delivery, our friendly team can bring your ideas to life.



## What We Offer



### Custom Fit Out Design

Save time and money, let our expert team design your fit out!



### 3D Renders

Complementary 3D renders allow our customers to better visualise their space.



### Competitive Prices

We know our prices are the best, that's why we provide a fully priced website and catalogue.



### Upholstery Services

We offer full upholstery services including repairs, reupholstery and custom fabrics.



### Customer Service

We're committed to providing high quality products and excellent customer service.



### Australia Wide Service

We deliver Australia wide, including metro and regional areas.

## How to shop with Schoolfurn

### Online

Search our impressive product range online. [www.schoolfurn.com.au](http://www.schoolfurn.com.au)

- Look through our portfolio
- Submit an online quote request
- See customer testimonies and recent projects
- Take advantage of our custom design services

### We come to you

Our sales team will gladly travel to your school or business to discuss your furniture needs.

- View furniture samples on site
- We can bring fabric and vinly swatches
- Our team can measure your space and provide expert advice to best suit your needs

### Visit our Showroom

Experience our products up close by visiting our Knoxfield showroom. Our friendly team will be happy to assist you and answer any questions you may have.

**Contact us to book an appointment;**  
**P. 1300 800 957**  
**E. [sales@schoolfurn.com.au](mailto:sales@schoolfurn.com.au)**

## Schoolfurn is now ISO 14001 & ISO 9001 certified!



Our **ISO 14001** certification reflects our commitment to responsible environmental management. This is an important step in our continued efforts to reduce our impact on the environment. We value ethical business practices and are taking an active role in reducing our carbon footprint.



Our **ISO 9001** certification reflects our commitment to quality, leadership, systems and the delivery of consistently safe products. We're passionate about providing high quality furniture, services and after sales assistance that exceeds our customers' expectations.

Graphics shown include photographs, illustrations and 3D renders. 3D renders are for illustrative purposes only. Despite our best efforts, 3D renders may differ slightly from actual products.

## Tables

Hercules Range	4-5
Height Adjustable	6-7
Collaborative	8-9
Individual & Sit Stand	10
Whiteboard Surface	11
Standing	12-13
Multipurpose	14-15
Breakout Tables	16-17

## Seating

i-Sit Range	18-19
Zed Range	20-21
Classroom Seating	22-25
Outdoor	25
Stools	26-27
Soft Seating	
Ottomax Range	28-29
Alcove Range	30
Ottomax Packages	31
Quad Range	32-33
Quad Packages	34-35
Quad Slim Range	36
Santo Range	37
Bean Bags	38

## Storage

Lockers	39
Viking Locker Range	40-41
Mobile Bag Units	42-43
Library Storage	44-45
Tote Box Storage	46-47

## Display & Presentation

Whiteboards	48
Pinboards	48
Wall Tiles	49
Freestanding Partition	49

## Office & Admin

Seating	
Admin	50-52
Visitor	50-52
Lounge	53
Nevada Range	54-55
Hercules Teacher	56
Montana Range	57
Electric Workstations	58
Boardroom	59
Executive Desking	60
Storage	61

## Colour Options

Zed & Squirle Colour Range	62
i-Sit Colour Range	62
Santo Colour Range	62
Quad Fabric Range	62
Standard Fabric Range	62
Standard Vinyl Range	63
Standard Table Top Range	63
Replacement Table Tops	63
Commercial Table Top Range	63
Extended Table Top Range	64



# Hercules Range

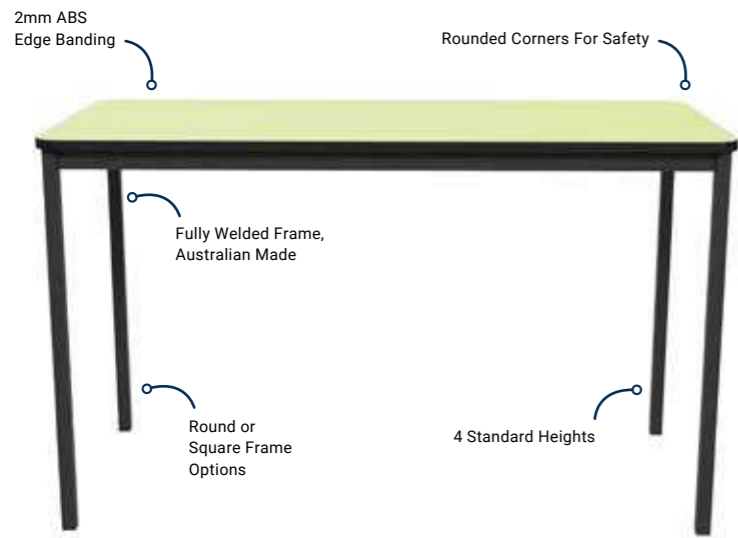

Hercules tables feature an easy-clean MDF table top and fully welded frame. Tops are available in 14 standard colours with custom options also available.

Frames are fully welded and finished in black powder coat for added durability. Standard heights include; 580, 620, 670 and 710mmH. Custom sizes are available at no additional cost.

Due to its modular design, tables can be used socially distanced or grouped together for collaborative projects.



## Table Top Colour Options



# Hercules Range

**Hercules 600**  
L600xD600, table height options; 580, 620, 670, 710. Custom heights available.



**\$109**  
+GST (\$119.90)



**Hercules 1200**  
L1200xD600, table height options; 580, 620, 670, 710. Custom heights available.



**\$125**  
+GST (\$137.50)



**Hercules Secondary Single**  
L700xD550, table height options; 580, 620, 670, 710. Custom heights available.



**\$109**  
+GST (\$119.90)



**Hercules Lynx**  
L1200xD600, table height options; 580, 620, 670, 710. Custom heights available.



**\$289**  
+GST (\$317.90)



**Hercules Round**  
1200DIA, table height options; 580, 620, 670, 710. Custom heights available.



**\$199**  
+GST (\$218.90)

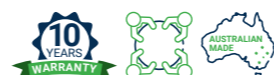

**Hercules Half Round**  
1200DIAx600, table height options; 580, 620, 670, 710. Custom heights available.



**\$159**  
+GST (\$174.90)





# Height Adjustable Tables

# Height Adjustable Tables



Ezy-Height Leg

T-Leg

Innovation Leg

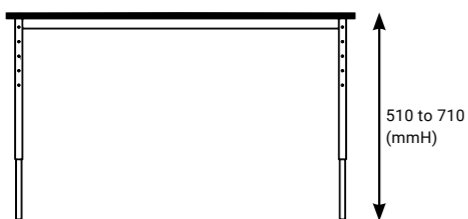

510 to 710 (mmH)

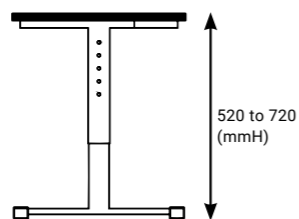

520 to 720 (mmH)

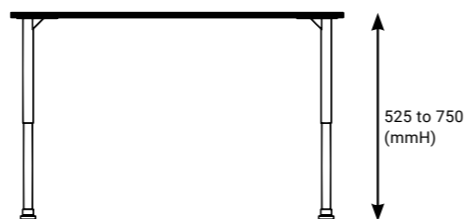

525 to 750 (mmH)

- Height range 510 to 710mmH
- Adjustable push pin legs
- Adjustable in 50mm increments
- Fully welded, Australian Made frame
- Black powder coat as standard

- Height range 520 to 720mmH
- Suitable for Prep to Year 12
- Protective plastic feet
- Horizontal base bar for stability
- Black powder coat as standard

- Height range 525 to 750mmH
- Fixed with self-locking screws
- Adjustable in 25mm increments
- Flat pack requires assembly
- Black and chrome finish as standard

## Ezy-Height Rectangular

L1200xD600 Without Totes \$199+GST (\$218.90)  
L1200xD600 With 2 SFX Totes \$224+GST (\$246.40)



From  
**\$199**  
+GST (\$218.90)



## Ezy-Height Round

1200DIA



**\$249**  
+GST (\$273.90)



## T-Leg 600

L600xD600 Without Tote \$180+GST (\$198.00)  
L600xD600 With 1 Tote \$195+GST (\$214.50)



From  
**\$180**  
+GST (\$198.00)



## T-Leg 1200

L1200xD600 Without Totes \$199+GST (\$218.90)  
L1200xD600 With 2 Totes \$224+GST (\$246.40)



From  
**\$199**  
+GST (\$218.90)



## Innovation Rectangular

L1200xD600



**\$159**  
+GST (\$174.90)



## Innovation Round

1200DIA



**\$209**  
+GST (\$229.90)





# Collaborative Tables

# Collaborative Tables

## Geo

L1360xD660, table height options; 580, 620, 670, 710. Custom heights available.

**Frame Options;**  
 Welded Frame **\$199+GST** (\$218.90) Innovation Leg **\$219+GST** (\$240.90)  
 Ezy-Height Leg **\$259+GST** (\$284.90)



From **\$199**  
+GST (\$218.90)

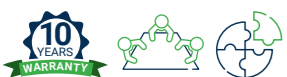

## Shield Segment

L1320xD1040, table height options; 580, 620, 670, 710. Custom heights available.

**Frame Options;**  
 Welded Frame **\$199+GST** (\$218.90) Innovation Leg **\$219+GST** (\$240.90)  
 Ezy-Height Leg **\$259+GST** (\$284.90)



From **\$199**  
+GST (\$218.90)

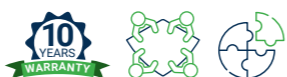

## Chomp

1200DIA, table height options; 580, 620, 670, 710. Custom heights available.

**Frame Options;**  
 Welded Frame **\$229+GST** (\$251.90) Innovation Leg **\$249+GST** (\$273.90)  
 Ezy-Height Leg **\$289+GST** (\$317.90)



From **\$229**  
+GST (\$251.90)

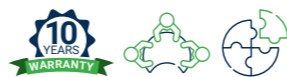

## Focus

1800DIAxD900, table height options; 580, 620, 670, 710. Custom heights available.

**Frame Options;**  
 Welded Frame **\$299+GST** (\$328.90) Innovation Leg **\$319+GST** (\$350.90)  
 Ezy-Height Leg **\$419+GST** (\$460.90)

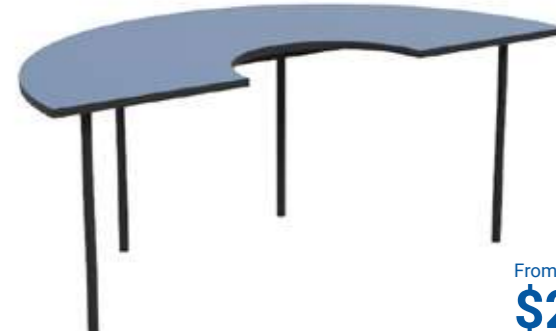

From **\$299**  
+GST (\$328.90)



## Shield Set

3 x Shield Segment. Table height options; 580, 620, 670, 710. Custom heights available.

**Frame Options;**  
 Welded Frame **\$597+GST** (\$656.70) Innovation Leg **\$617+GST** (\$678.70)  
 Ezy-Height Leg **\$777+GST** (\$854.70)



From **\$597**  
+GST (\$656.70)

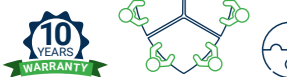

## League

2 x Geo, 2 x Shield Segment. Table height options; 580, 620, 670, 710. Custom heights available.

**Frame Options;**  
 Welded Frame **\$796+GST** (\$875.60) Innovation Leg **\$816+GST** (\$897.60)  
 Ezy-Height Leg **\$1,036+GST** (\$1,139.60)



From **\$796**  
+GST (\$875.60)

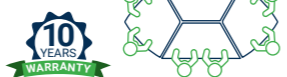

## Cloud 4

L1200xD1200, table height options; 580, 620, 670, 710. Custom heights available.

**Frame Options;**  
 Welded Frame **\$229+GST** (\$251.90) Innovation Leg **\$249+GST** (\$273.90)  
 Ezy-Height Leg **\$299+GST** (\$328.90)



From **\$229**  
+GST (\$251.90)

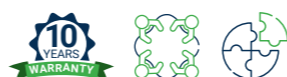

## Cloud 6

L1800xD1200, table height options; 580, 620, 670, 710. Custom heights available.

**Frame Options;**  
 Welded Frame **\$339+GST** (\$372.90) Innovation Leg **\$359+GST** (\$394.90)  
 Ezy-Height Leg **\$419+GST** (\$460.90)



From **\$339**  
+GST (\$372.90)

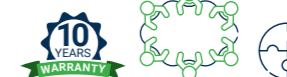

## Octave

L1470xD600, fully welded Australian Made frame, modular design for use with Quad soft seating, 18mm table top, available in 13 standard colours, custom table heights available.



**\$389**  
+GST (\$427.90)



**Flexibility for every learning space!**





# Individual & Sit Stand Tables

# Whiteboard Surface

## Study Carrel

L750xD750x710/1110mmH, privacy screens for focused learning, Australia Made, ABS protective edge banding, fully welded, Australian Made frame.



**10 YEARS WARRANTY**  
 \$339 +GST (\$372.90)



## Hercules Electric Sit/Stand

L1200xD600, single motor, 720 to 1150mmH, 80kg lift power, built-in controller, black or white frame.



**10 YEARS WARRANTY**  
 \$495 +GST (\$544.50)



Enhance classroom engagement with Whiteboard Tables. Students can write and draw directly on their table for a fun and interactive learning experience. Maintain surfaces by wiping down with a microfibre cloth after class.

Tops have rounded safety corners and protective ABS edge banding. Choose from our wide range of sizes and styles to best suit your needs. Fixed and height adjustable leg options are available for added flexibility.

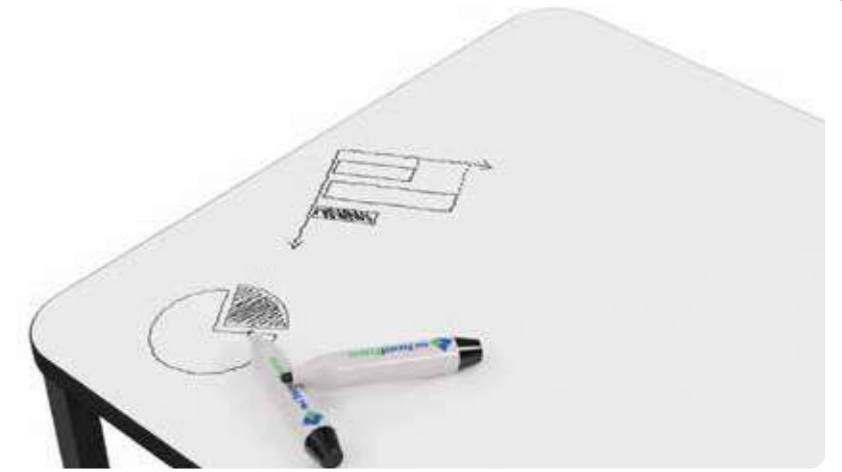

## T-Max

L700xD550x710mmH, black steel frame, tops available in 5 colour options, ABS edge banding.



**7 YEARS WARRANTY**  
 \$99 +GST (\$108.90)

## Pipee Exam

L750xD550x725mmH, stackable design, made from durable plastic, easy clean material.



**10 YEARS WARRANTY**  
 \$65 +GST (\$71.50)

## Exam Pro

L755xD500D740mmH, metal frame with plastic top. Folding legs for easy storage.



**10 YEARS WARRANTY**  
 \$99 +GST (\$108.90)

## Surge Sit & Stand

L700xD550, adjustable podium 720 to 1030mmH. Available with wire book basket.



With Book Basket  
 \$499.00+GST

**7 YEARS WARRANTY**  
 From \$449 +GST (\$493.90)

## Boost Sit & Stand

L700xD500, adjustable from 730 to 1030mmH. Rear castors, inbuilt gas lift and book tray.



**7 YEARS WARRANTY**  
 \$279 +GST (\$306.90)

## Hotspot Sit & Stand

L1200xD600, adjustable from 750 to 1200mmH. Plug In Model \$550+GST (\$605.00) Battery Model \$690+GST (\$759.00)



**5 YEARS WARRANTY**  
 From \$550 +GST (\$605.00)



**Simply wipe down after class!**





# Standing Tables

# Standing Tables

**Hercules Standing Round**  
L1200DIA, table height options; 900 or 1050mmH.



**\$229**  
+GST (\$251.90)



**Hercules Standing 1200**  
L1200xD600, table height options; 900 or 1050mmH.



**\$179**  
+GST (\$196.90)



**Art & Science 1200 Standing**  
L1200xD600, table height options; 900 or 1050mmH.



**\$229**  
+GST (\$251.90)



Capacity: 24



**Get the look!**  
4 x Thor Standing Octave, 2 x Quad Cave, 3 x Quad Banq, 3 x Hercules Standing 1200, 4 x Hart Laptop Table, 14 x Zed Science  
Price as shown; **\$5,349.00**+GST (\$5,883.90)



**Octave Standing**  
L1470xD600x900mmH, compact design, ideal for high-capacity spaces, fully welded frame, modular design.



**NEW!**

**\$419**  
+GST (\$460.90)

**Art & Science 1800 Standing**  
L1800xD750, table height options; 900 or 1050mmH.



**\$339**  
+GST (\$372.90)



**Cloud 6 Standing**  
Table height options; 900 or 1050mmH.

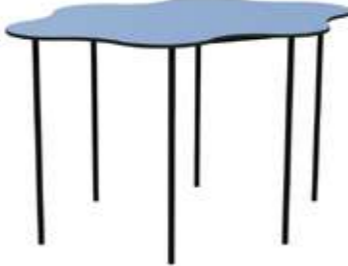

**\$389**  
+GST (\$427.90)



**Lynx Standing**  
L1200xD600, rounded safety corners, fully welded frame. Table height options; 900 or 1050mmH.



**\$319**  
+GST (\$350.90)



Capacity: 16



**Get the look!**  
3 x Thor Standing, 2 x Quad Cave, 1 x Verse 1200DIA, 3 x Ottomax Round, 9 x Zed Science  
Price as shown; **\$4,749**+GST (\$5,196.40)



**Thor Standing**  
L1900xD600x900mmH, Suitable for secondary aged students, modular design, fully welded frame, black powder coat as standard.



**\$469**  
+GST (\$515.90)

**Group Standing**  
L1800xD750, table height options; 900 or 1050mmH.



**\$295**  
+GST (\$324.50)



**A-Frame Standing**  
L1800xD900. Table height options; 900 or 1050mmH. Custom table tops and frame colour options available.



**\$439**  
+GST (\$482.90)



**Lockable Castors**  
Upgrade tables to include lockable castors. Castors are available for all table heights including standing.



**\$60**  
+GST (\$66.00)



Capacity: 13



**Get the look!**  
3 x Thor Standing Modesty Panel, 2 x Quad Slim Cave, 1 x Verse 1200DIA, 9 x Zed Science  
Price as shown; **\$8,999**+GST (\$9,898.90)



**Thor Standing with Modesty Panel**  
L1900xD600x900mmH, perforated steel modesty panel, modular design, fully welded frame, black powder coat as standard.



**\$690**  
+GST (\$759.00)

Graphics shown include photographs, illustrations and 3D renders. 3D renders are for illustrative purposes only. Despite our best efforts, 3D renders may differ slightly from actual products.





Flip table tops for easy storage!



### Vee Table

25mm table top, tapered frame in Black or White, table height 720mmH.  
 L1200xD600 **\$209+GST** (\$229.90) L1800xD600 **\$239+GST** (\$262.90)  
 L1500xD750 **\$259+GST** (\$284.90) L1800xD750 **\$269+GST** (\$295.90)



From **\$209**  
+GST (\$229.90)

### Universal

25mm table top, 32mm square frame, table height 720mmH.  
 L1350xD675 **\$259+GST** (\$284.40) L1500xD750 **\$279+GST** (\$306.90)  
 L1800xD750 **\$319+GST** (\$350.90) L1800xD900 **\$329+GST** (\$361.90)  
 L2100xD900 **\$379+GST** (\$416.90)



From **\$259**  
+GST (\$284.40)

### Metro Meeting

720mmH, height adjustable feet, 25mm table top, two tone metal frame, available in 6 standard colours, custom colours available.  
 L1500xD750 **\$299+GST** (\$328.90)  
 L1800xD900 **\$299+GST** (\$328.90)



**\$299**  
+GST (\$328.90)

### Flip & Store Round

Easy-use flip mechanism, space saving design, store tops vertical, lockable castors, protective 2mm ABS edge banding, available in 6 colours.  
 900DIA **\$399+GST** (\$438.90)  
 1200DIA **\$449+GST** (\$493.90)



From **\$399**  
+GST (\$438.90)

### Flip & Store Rectangular

Easy-use flip mechanism, space saving design, store tops vertical, lockable castors, protective 2mm ABS edge banding, available in 6 colours.  
 L1500xD750 **\$419+GST** (\$460.90)  
 L1800xD900 **\$439+GST** (\$482.90)



### Agile Flip

Flip mechanism for vertical storage, space saving design, store tops vertical, lockable castors, available in 4 sizes and 6 colours.  
 L1500xD750 **\$619+GST** (\$680.90) L1800xD900 **\$619+GST** (\$680.90)  
 L1800xD750 **\$619+GST** (\$680.90) L2400xD1200 **\$899+GST** (\$988.90)



From **\$619**  
+GST (\$680.90)



# Breakout Tables

Breakout tables work seamlessly with our range of soft seating and visitor chairs. Designs range from contemporary to more traditional styles to best complement your interior.

All laptop table bases are designed to slide under soft seating. Allowing for easy accessibility and function.



Ottomax Wedge, Eclipse Coffee Table 900DIA

Alcove Booth Medium 2000, Delta 900DIA, Basix 4 Way 900DIA

Quad Banq 1200, Verse Coffee Table 600DIA



# Breakout Tables

**Air Round**  
600DIAx450mmH, 25mm table top, metal cross frame, protection plastic feet.

**Air Square**  
600x600x450mmH, 25mm table top, metal cross frame, protection plastic feet.

**Air Oval**  
1200x600x450mmH, 25mm table top, metal cross frame, protection plastic feet.



7 YEARS WARRANTY  
From **\$130**  
+GST (\$143.00)

7 YEARS WARRANTY  
**\$130**  
+GST (\$143.00)

7 YEARS WARRANTY  
**\$320**  
+GST (\$352.00)

## Basix Range

Coffee 4 Way Frame (450H) 600DIA **\$130+GST** (\$143.00)  
Table 4 Way Frame (730H) 900DIA **\$230+GST** (\$253.00)  
Table 5 Way Frame (730H) 1200DIA **\$270+GST** (\$297.00)



5 Way 1200DIA

4 Way 600DIA

7 YEARS WARRANTY  
From **\$130**  
+GST (\$143.00)

## Delta Table Range

3 Way Frame (720H) 900DIA **\$299+GST** (\$328.90)  
4 Way Frame (720H) 900DIA **\$349+GST** (\$383.90) 1200DIA **\$389+GST** (\$427.90)



4 Way 1200DIA

3 Way 900DIA

7 YEARS WARRANTY  
From **\$299**  
+GST (\$328.90)

## Verse Range

Coffee (450H) 600DIA **\$190+GST** (\$209.00) 750DIA **\$249+GST** (\$272.90)  
Table (720H) 750DIA **\$295+GST** (\$324.50) 900DIA **\$295+GST** (\$324.50)  
1200DIA **\$359+GST** (\$394.90)  
Bar (1050H) 750DIA **\$320+GST** (\$352.00)



Bar 1050mmH

Table 720mmH

Coffee 450mmH

7 YEARS WARRANTY  
From **\$190**  
+GST (\$209.00)

## Eclipse Coffee Table Range

Metal tube frame, black powder coat, raised rim, available in 3 standard sizes.  
500DIA (500H) **\$309+GST** (\$339.90)  
700DIA (460H) **\$409+GST** (\$449.90)  
900DIA (450H) **\$439+GST** (\$482.90)



900DIA

700DIA

7 YEARS WARRANTY  
From **\$309**  
+GST (\$339.90)

## Eternity Laptop Table

W300xD400x600mmH, fully welded metal frame, frame available in black or white powder coat, durable MDF worksurface.



7 YEARS WARRANTY  
**\$109**  
+GST (\$119.90)

## Hart Laptop Table

W305xD410, 440 or 600mmH, metal disk base, MDF worksurface, rounded corners and edge profile.



7 YEARS WARRANTY  
**\$179**  
+GST (\$196.90)

## Link Laptop Table

W340xD470x648mmH, dual purpose, use as both a laptop stand and coffee table, plywood veneer.



7 YEARS WARRANTY  
**\$349**  
+GST (\$383.90)



# i-Sit Range

# i-Sit Range



**BIFMA**  
ANSI/BIFMA X5.1 Accredited

**10 YEARS WARRANTY**  
10 Year Warranty

**120kg Capacity**  
120kg Capacity

Easy Clean

Stackable

Anti-tilt Design

Made from UV stabilised plastic, i-Sit Chairs are fade resistant and 100% recyclable. Chairs are ANSI/BIFMA accredited and have a 120kg weight capacity. I-Sit chairs have an ergonomic backrest and feature an anti-tilt leg design.

Chairs are easy to clean, light weight and stackable for no-fuss storage and transportation. As a testament to their quality and performance, i-Sit Chairs come with a 10 year warranty.



Suitable for Prep to Year 12 students!

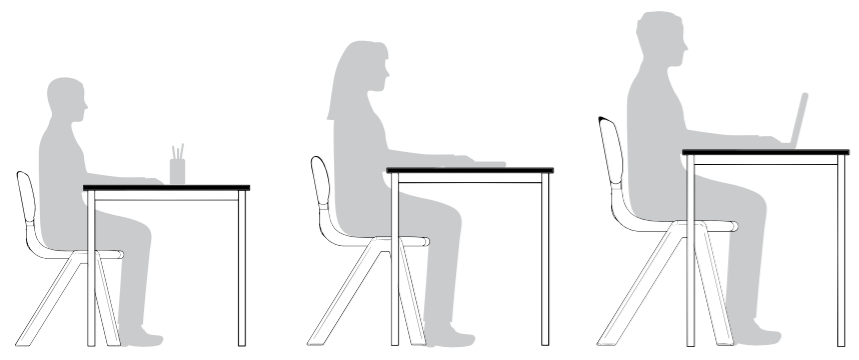

**i-Sit Junior** Tables 580mmH  
**i-Sit Primary** Tables 640mmH  
**i-Sit Secondary** Tables 710mmH



**Get the look!**  
2 x T-Leg 1200 with 2 SFX Totes, 4 x i-Sit Junior

**10 YEARS WARRANTY** **BIFMA**

Color swatches: yellow, green, blue, red, grey, black



**i-Sit Junior**  
Seat height 350mmH. Suitable for Kinder, Prep, Grade 1.

**\$28**  
+GST (\$30.80)



**Get the look!**  
1 x Cloud 6, 4 x i-Sit Primary

**10 YEARS WARRANTY** **BIFMA**

Color swatches: yellow, green, blue, red, grey, black



**i-Sit Primary**  
Seat height 400mmH. Suitable for Grades 2 to 5.

**\$33**  
+GST (\$36.30)



**Get the look!**  
4 x Secondary Single, 4 x i-Sit Secondary

**10 YEARS WARRANTY** **BIFMA**

Color swatches: yellow, green, blue, red, grey, black



**i-Sit Secondary**  
Seat height 460mmH. Suitable for Grades 5 to 12.

**\$37**  
+GST (\$40.70)



# Zed Range

# Zed Range



**15 YEARS WARRANTY**  
15 Year Warranty

**BIFMA**  
ANSI/BIFMA X5.1 Accredited

**CERTIFIED GREEN**  
Certified Green

**Ergonomic**

**Easy Clean**

**Stackable**

Engineered in the USA, Zed chairs are constructed using injection moulding processes. The result is a seamless finish that provides increased strength and flexibility.

Backrests are designed to flex with the body, providing continued ergonomic support. Chairs are easy to clean, making them ideal for busy learning spaces. Zed Chairs are Certified Green, BIFMA accredited, stackable and supported by a 15 year warranty.



**Zed chairs are ideal for dynamic learning spaces!**

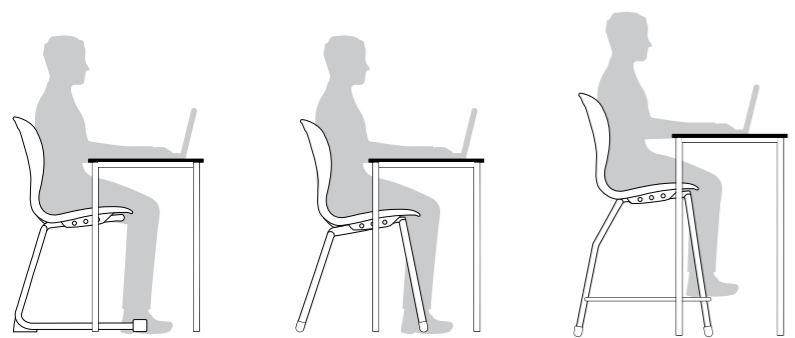

**Zed Cantilever** Tables 640 to 710mmH  
**Zed 4 Leg** Tables 560 to 710mmH  
**Zed Science** Tables 780 to 900mmH



**Zed Cantilever 400**  
Seat height 400mmH



**\$95**  
+GST (\$104.50)

**Zed Cantilever 460**  
Seat height 460mmH



**\$95**  
+GST (\$104.50)

**Zed 4 Leg 350**  
Seat Height; 350mmH



**\$72**  
+GST (\$79.20)

**Zed 4 Leg 400**  
Seat Height; 400mmH



**\$82**  
+GST (\$90.20)

**Zed 4 Leg 460**  
Seat Height; 460mmH



**\$82**  
+GST (\$90.20)

**Zed Gas Lift**  
Seat height range 430 to 585mmH



**\$115**  
+GST (\$126.50)

**Zed Science**  
550mmH **\$149+GST (\$163.90)**  
650mmH **\$159+GST (\$174.90)**  
600mmH **\$155+GST (\$170.50)**



From **\$149**  
+GST (\$163.90)





Get the look with our custom upholstery services!

Contact us to learn more

P. 1300 800 957  
E. sales@schoolfurn.com.au

### Inspiration Cantilever

Seat height 460mmH. Made in USA, integrated carry handle, protective plastic feet.



**\$85**  
+GST (\$93.50)

### Inspiration Gas Lift

Height range; 430 to 580mmH. Made in USA, easy clean materials, heavy duty castors.



**\$99**  
+GST (\$108.90)

### Inspiration Science

Seat heights; 550, 600, 650mmH. Made in USA, welded frame, foot rail for added support.



**\$149**  
+GST (\$163.90)

### Active Chair

Seat height 450mmH, upholstered seat, perforated backrest, black sled frame, linkable feet, custom fabrics available.



**\$99**  
+GST (\$108.90)

### Active Tablet

Seat height 450mmH, upholstered seat, perforated backrest, black sled frame, protective feet, built-in tablet arm, ample work surface, custom fabrics available.



**\$139**  
+GST (\$152.90)

### Aero Chair

Seat height 450mmH, plastic seat and backrest, perforated design, chrome sled frame, protective feet, stackable.



**\$85**  
+GST (\$93.50)

### Aero Upholstered

Seat height 450mmH, perforated backrest, chrome sled frame, protective feet, stackable, fabric upholstered seat, custom fabrics available.



**\$115**  
+GST (\$126.50)

### Aero Stool

Seat height 650mmH, chrome frame, perforated plastic backrest, ideal for tables 900mmH. Aero Plastic **\$119**+GST (\$130.90) Aero Upholstered **\$149**+GST (\$163.90)



**\$119**  
+GST (\$130.90)

### Active Stool

Seat height 750mmH, upholstered seat, perforated backrest, black sled frame, protective feet, custom fabrics available.



**\$139**  
+GST (\$152.90)



# Classroom Seating

# Classroom Seating

**Techno**  
Seat height 445mmH, Australian Made, stackable.



**\$20**  
+GST (\$22.00)

**Pipee**  
Seat height 445mmH, light weight plastic, stackable.



**\$25**  
+GST (\$27.50)

**Classic Student**  
Welded frame, plastic seat and backrest.  
350mmH **\$89**+GST(\$97.90) 390mmH **\$92**+GST(\$101.20)  
445mmH **\$95**+GST(\$104.50)



From **\$89**  
+GST (\$97.90)

**Peekaboo Stool**  
L400xD410x467mmH, stackable, inbuilt backrest and carry handle, IF Design Award winner 2020.



**\$69**  
+GST (\$75.90)

**Stakka Stool**  
L400xD410x467mmH, plastic seat with foam insert, chrome frame, stackable, protective plastic feet.



**\$49**  
+GST (\$53.90)

**Stakka Stool Upholstered**  
L400xD410x467mmH, fabric upholstery, memory foam seat, chrome frame, stackable, protective plastic feet.



**\$79**  
+GST (\$86.90)

**Acti Chair**  
Seat height 450mmH, black powder coat frame, ergonomic backrest, 110kg weight capacity.



**\$129**  
+GST (\$141.90)

**Acti Eco Chair**  
Seat height 450mmH, timber legs, plastic seat.



**\$129**  
+GST (\$141.90)

**Acti Stool**  
Seat heights; 630, 760mmH. Chrome frame, foot rail for added support.



**\$159**  
+GST (\$174.90)

## Outdoor Furniture



Extended range online!

**Pod Tablet 4 Leg**  
Seat height 480mmH, inbuilt tablet arm, 120kg weight capacity, chrome frame, easy clean plastic seat.



**\$159**  
+GST (\$174.90)

**Pod Tablet Sled**  
Seat height 480mmH, inbuilt tablet arm, upholstery options available, chrome sled frame with protective feet.



**\$175**  
+GST (\$192.50)

**Pod Tablet Upholstered**  
Seat height 480mmH, upholstered seat and backrest, chrome 4 leg frame, inbuilt tablet arm.



**\$269**  
+GST (\$295.90)

**Wimbledon Seat**  
L1600xD490x835mmH, ModWood battens, high UV stability, weather and pest resistant, easy clean material, black powder coat steel frame.



**\$1,450**  
+GST (\$1,595.00)

**Court Side Table Set**  
L1770xD840x750mmH, ModWood battens, UV stabilised, weather and pest resistant, black powder coat steel frame.



Set Price **\$2,385**  
+GST (\$2,623.50)

**Camp Fire Table**  
L2255xD2255x770mmH, 485H seat, ModWood battens, UV stabilised, weather and pest resistant.



**\$2,650**  
+GST (\$2,915.00)



# Stools

# Sensory Stools

**Activity**  
Height range 450 to 650mmH, height adjustable frame, levelling feet, suitable for tables 690 to 900mmH.



**5 YEARS WARRANTY**  
**\$99**  
+GST (\$108.90)

**Beast**  
Seat heights; 450, 550, 600, 650mmH. Embossed PU seat, fully welded frame, black powder coat finish.



**10 YEARS WARRANTY**  
**\$119**  
+GST (\$130.90)

**Ergo Stool**  
Seat height range; 420 to 550mmH. Adjustable gas lift, available with castors or glides, PVC seat or upholstered.



Polyurethane Model  
**\$119+GST**

**5 YEARS WARRANTY**  
**\$139**  
+GST (\$152.90)

**Tamba**  
Seat heights; 370, 450mmH



**5 YEARS WARRANTY**  
**\$59**  
+GST (\$64.90)

**Squircle® - Fixed Height**  
Seat heights; 375, 460mmH



**15 YEARS WARRANTY**  
**\$69**  
+GST (\$75.90)

**Squircle® - Adjustable Height**  
Seat height range; 390 to 500mmH



**NEW!**

**15 YEARS WARRANTY**  
**\$119**  
+GST (\$130.90)

**Retro Stool**  
Seat heights; 550, 600, 650mmH. MDF laminate seat, fully welded frame, foot rail for added support.



**5 YEARS WARRANTY**  
**\$99**  
+GST (\$108.90)

**Classic Art**  
Seat heights; 550, 600, 650mmH. Plastic seat, fully welded frame, stackable design.



**10 YEARS WARRANTY**  
**\$115**  
+GST (\$126.50)

**Cobra**  
Seat height 650mmH. Curved frame, black powder coat, designed for table top storage, suits 900mmH tables.



**5 YEARS WARRANTY**  
**\$119**  
+GST (\$130.90)

**Lobax**  
Seat height 650mmH. Molded seat, matte black finish, black sled frame, supportive foot rail.



**5 YEARS WARRANTY**  
**\$99**  
+GST (\$108.90)

**Classic Science**  
Seat heights; 550, 600, 650mmH. Standing height stool, plastic seat and backrest, metal frame with foot rail.



**10 YEARS WARRANTY**  
**\$135**  
+GST (\$148.50)

**Aero Stool**  
Seat height 650mmH. Chrome frame, perforated plastic backrest, durable plastic seat, upholstery available.



Upholstery  
**\$149+GST**

**7 YEARS WARRANTY**  
**\$119**  
+GST (\$130.90)



**Sensory stools aid concentration and posture!**



Sensory stools are designed to sway, providing an energy outlet for active students. Stools feature a domed non-slip base and easy-grip waterfall edge. Engineered in the USA, stools are self-righting and rest in an upright position when not in use. Sensory stools are popular in classrooms, break out areas and STEM learning spaces.





- 7 Year Warranty
- Modular Design
- Custom Options

Ottomax soft seating is popular for its thick foam padding and modular design. Products are not only comfortable but highly flexible and durable.

Upholstery is available in both commercial grade fabric and easy-clean vinyl. Purchase units individually or as a package for added value. Made in Australia by our expert team, Ottomax products provide high quality at affordable prices.

- Breakout Spaces
- Receptions
- Classrooms
- Library Areas
- STEM
- Play Rooms



## Upholstery Options

- |                    |        |        |        |      |          |                     |        |       |       |          |       |
|--------------------|--------|--------|--------|------|----------|---------------------|--------|-------|-------|----------|-------|
| <b>House Vinyl</b> |        |        |        |      |          | <b>Spark Fabric</b> |        |       |       |          |       |
|                    |        |        |        |      |          |                     |        |       |       |          |       |
| Apple              | Marine | Sunset | Chilli | Plum | Charcoal | Moss                | Lagoon | Tango | Flame | Eggplant | Storm |

**Ottomax Round**  
450DIAx450mmH



**\$109**  
+GST (\$119.90)

- 7 YEARS WARRANTY
- Vinyl
- Fabric

**Ottomax Square**  
450x450mmH



**\$109**  
+GST (\$119.90)

- 7 YEARS WARRANTY
- Vinyl
- Fabric

**Ottomax Wedge**  
L1800xD450x450mmH



**\$475**  
+GST (\$522.50)

- 7 YEARS WARRANTY
- Vinyl

**Ottomax Rectangle 1200**  
L1200xD450x450mmH



**\$295**  
+GST (\$324.50)

- 7 YEARS WARRANTY
- Vinyl
- Fabric

**Ottomax Rectangle 1500**  
L1500xD450x450mmH



**\$345**  
+GST (\$379.50)

- 7 YEARS WARRANTY
- Vinyl
- Fabric

**Ottomax Rectangle 1800**  
L1800xD450x450mmH



**\$395**  
+GST (\$434.50)

- 7 YEARS WARRANTY
- Vinyl
- Fabric

**Ottomax Sit Store 6**  
L1092xD460x450mmH, 6 x Totes, lockable castors



**\$525**  
+GST (\$577.50)

- 7 YEARS WARRANTY
- 

**Ottomax Sit Store 8**  
L1450xD460x450mmH, 8 x Totes, lockable castors



**\$595**  
+GST (\$654.50)

- 7 YEARS WARRANTY
- 

**Ottomax Squish**  
450DIAx80mmH



Trolley Package  
**\$795+GST**

- 7 YEARS WARRANTY
- Vinyl
- \$49**  
+GST (\$53.90)

Graphics shown include photographs, illustrations and 3D renders. 3D renders are for illustrative purposes only. Despite our best efforts, 3D renders may differ slightly from actual products.



# Alcove Range

# Ottomax Packages

## Alcove Booth Low 1000

L1025xD830x1020mmH, GECA certified antibacterial foam, custom fabric options available, stainless steel feet.

**NEW!**



From **\$1,585**  
+GST (\$1,743.50)



## Alcove Booth Medium 1000

L1025xD830x1320mmH, GECA certified antibacterial foam, custom fabric options available, stainless steel feet.

**NEW!**



From **\$1,785**  
+GST (\$1,963.50)



## Alcove Booth High 1000

L1025xD830x1620mmH, GECA certified antibacterial foam, custom fabric options available, stainless steel feet.

**NEW!**



From **\$2,090**  
+GST (\$2,299.00)



## Ottomax Round 6

6 x Ottomax Round



Vinyl **\$630**  
Fabric +GST (\$693.00)

## Ottomax Square 6

6 x Ottomax Square



Vinyl **\$630**  
Fabric +GST (\$693.00)

## Alcove Booth Low 1500

L1525xD830x1020mmH, GECA certified antibacterial foam, custom fabric options available, stainless steel feet.

**NEW!**



From **\$1,785**  
+GST (\$1,963.50)



## Alcove Booth Medium 1500

L1525xD830x1320mmH, GECA certified antibacterial foam, custom fabric options available, stainless steel feet.

**NEW!**



From **\$2,030**  
+GST (\$2,233.00)



## Alcove Booth High 1500

L1525xD830x1620mmH, GECA certified antibacterial foam, custom fabric options available, stainless steel feet.

**NEW!**



From **\$2,360**  
+GST (\$2,596.00)



## Ottomax All Rounder

1 x All Rounder Table (1000DIA), 4 x Ottomax Segment (L450xD450), 25mm table top, tables available in 7 colours, custom options available, see website for details.

Table 500mmH **\$899**+GST (\$988.90)  
Table 710mmH **\$899**+GST (\$988.90)

**NEW!**



Table 500mmH

Table 710mmH



Vinyl **\$899**  
Fabric +GST (\$988.90)

## Ottomax Mix

2 x Ottomax Round, 2 x Ottomax Wedge, 2 x Ottomax Square



Vinyl **\$1,360**  
+GST (\$1,496.00)

## Alcove Booth Low 2000

L2025xD830x1020mmH, GECA certified antibacterial foam, custom fabric options available, stainless steel feet.

**NEW!**



From **\$2,050**  
+GST (\$2,255.00)



## Alcove Booth Medium 2000

L2025xD830x1320mmH, GECA certified antibacterial foam, custom fabric options available, stainless steel feet.

**NEW!**



From **\$2,290**  
+GST (\$2,519.00)



## Alcove Booth High 2000

L2025xD830x1620mmH, GECA certified antibacterial foam, custom fabric options available, stainless steel feet.

**NEW!**



From **\$2,990**  
+GST (\$3,289.00)



## Ottomax Unite

4 x Ottomax Wedge

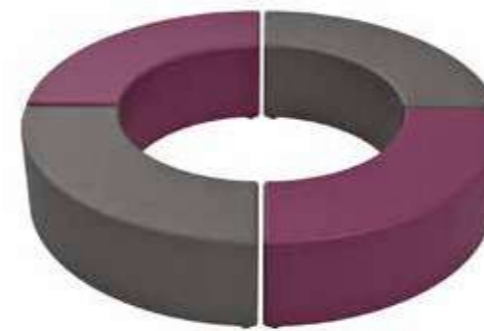

Vinyl **\$1,880**  
+GST (\$2,068.00)

## Ottomax Pursuit

3 x Ottomax Rectangle 1200, 4 x Ottomax Segment



**NEW!**













Vinyl **\$1,629**  
+GST (\$1,791.90)





### Leg Options

					
<b>Lockable Castors</b> 75DIAx100mmH	<b>Square Chrome Leg</b> L50xD50x100mmH	<b>Matte Black T Leg</b> L130xD130x95mmH	<b>Tapered Wooden Leg</b> L75xD75x100mmH	10 Year Warranty	460mm Seat Height
					
				Australian Made	Custom Options

### Upholstery Options

<b>Luna Fabric</b>						<b>Spark Fabric</b>					
											
Apple Luna	Marine Luna	Sunset Luna	Chilli Luna	Plum Luna	Charcoal Luna	Moss Spark	Lagoon Spark	Tango Spark	Flame Spark	Eggplant Spark	Storm Spark

**Quad Round Ottoman**  
600DIA (460mmH) **\$259**+GST (\$284.90)  
900DIA (460mmH) **\$359**+GST (\$394.90)  
1200DIA (460mmH) **\$459**+GST (\$504.90)





From **\$259**  
+GST (\$284.90)

 Vinyl   
Fabric 

**Quad Half Round Ottoman**  
1200DIAx460mmH





**\$395**  
+GST (\$434.50)

 Vinyl   
Fabric 

**Quad D-End Ottoman**  
L900xD600x460mmH









**\$345**  
+GST (\$379.50)

 Vinyl   
Fabric 

**Quad Chair**  
L600xD600x800mmH, seat height 460mmH



**\$545**  
+GST (\$599.50)

 Luna   
Spark 

**Quad Banq 1200**  
L1200xD600x800mmH, seat height 460mmH





**\$745**  
+GST (\$819.50)

 Luna   
Spark 

**Quad Banq 1500**  
L1500xD600x800mmH, seat height 460mmH



**\$795**  
+GST (\$874.50)

 Luna   
Spark 

**Quad Banq 1800**  
L1800xD600x800mmH, seat height 460mmH



**\$845**  
+GST (\$929.50)

 Luna   
Spark 

**Quad Cave**  
R1300xD600x800mmH, seat height 460mmH





**\$1,095**  
+GST (\$1,204.50)

 Luna   
Spark 

**Quad Vex**  
R1300xD600x800mmH, seat height 460mmH



**\$1,095**  
+GST (\$1,204.50)

 Luna   
Spark 



# Quad Packages

# Quad Packages

Capacity: 9

**Quad Share**  
L2600xD1300x800mmH, seat height 460mmH, 2 x Quad Cave



**Get the look!**  
1 x Quad Share, 1 x Verse 1200DIA (720mmH) Table, 3 x Ottomax Round



**\$2,150**  
+GST (\$2,365.00)

**Quad Twist**  
L3270xD600x800mmH, seat height 460mmH, 1 x Quad Cave, 1 x Quad Vex



**\$2,150**  
+GST (\$2,365.00)

**Quad Booth**  
2 x Quad Banq 1500, 1 x Metro Meeting (L1500xD750x720mmH)



**\$1,850**  
+GST (\$2,035.00)

Capacity: 6

**Quad Library**  
L3500xD1770, seat height 460mmH, 2 x Quad Cave, 4 x Quad Bookcase  
800H bookcase **\$5,190**+GST (\$5,709.00)  
1200H bookcase **\$5,490**+GST (\$6,039.00)



**Get the look!**  
1 x Quad Library, 1 x Verse 1200DIA (720mmH) Table



From **\$5,190**  
+GST (\$6,709.00)

**Quad Mirror**  
L3640xD1060x800mmH, seat height 460mmH, 2 x Quad Cave, 2 x Mirror Cave, 1 x Quad Vex, x Mirror Vex

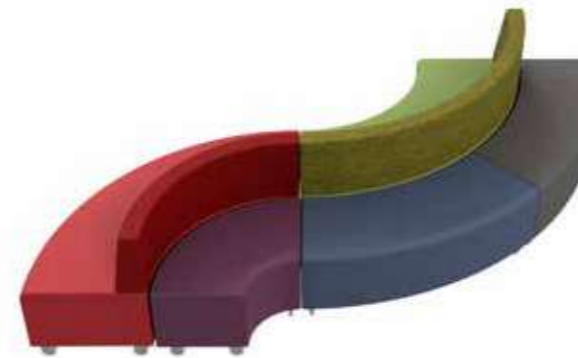

**\$3,450**  
+GST (\$3,795.00)

**Quad Track**  
L2700xD1200x800mmH, seat height 460mmH, 2 x Quad Banq 1500, 2 x Quad Half Round Ottoman



**\$2,280**  
+GST (\$2,508.00)

Capacity: 24

**Quad Elevation**  
2 x Quad Cave, 3 x Quad Banq 1200, 4 x Thor Standing Octave, 3 x Hercules Standing 1200

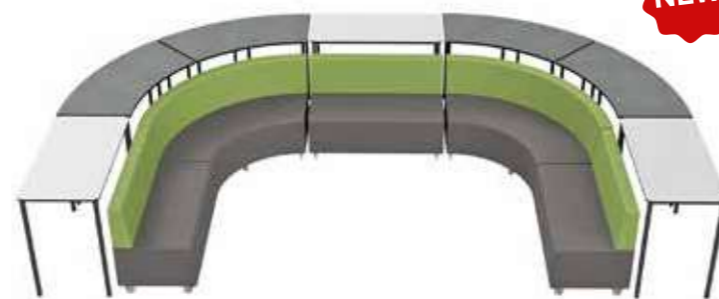

**Get the look!**  
1 x Quad Elevation, 5 x Hart Laptop Table, 14 x Zed Science



**\$6,590**  
+GST (\$7,249.00)

**Quad Pebble Packages**  
Quad Round Ottoman 900DIA, 4 x Ottomax Round **\$760**+GST (\$836.00)  
Quad Round Ottoman 1200DIA, 5 x Ottomax Round **\$870**+GST (\$957.00)



From **\$760**  
+GST (\$836.00)

**Quad Welcome**  
L3600xD600x800mmH, seat height 460mmH, 1 x Quad Banq 1800, 2 x Quad D-End Ottoman



**\$1,435**  
+GST (\$1,578.50)



# Quad Slim Range

# Santo Range

**Quad Slim Bench 1200**  
L1200xD450x450mmH



Vinyl **\$249**  
Fabric +GST (\$273.90)

**Quad Slim Bench 1500**  
L1500xD450x450mmH



Vinyl **\$299**  
Fabric +GST (\$328.90)

**Quad Slim Bench 1800**  
L1800xD450x450mmH



Vinyl **\$369**  
Fabric +GST (\$405.90)

**Quad Slim Cave**  
R1300xD450x450mmH



Vinyl **\$599**  
Fabric +GST (\$658.90)

Capacity, 12



**Get the look!**  
Quad Slim Benches nest neatly under table tops for easy storage.



Vinyl **Spark**

**Quad Slim Booth**  
2 x Quad Slim Bench 1200, 1 x Vee Table L1500xD750 (720mmH)



**\$799**  
+GST (\$878.90)

Capacity, 12



**Get the look!**  
1 x Quad Slim Family, 1 x Verse 1200DIA Table, 9 x Zed Science  
Price as shown; **\$4,995+GST (\$5,494.50)**



Vinyl **Spark**

**\$3,299**  
+GST (\$3,628.90)

**Quad Slim Family**  
2 x Quad Slim Cave, 3 x Thor Standing with Modesty Panels.

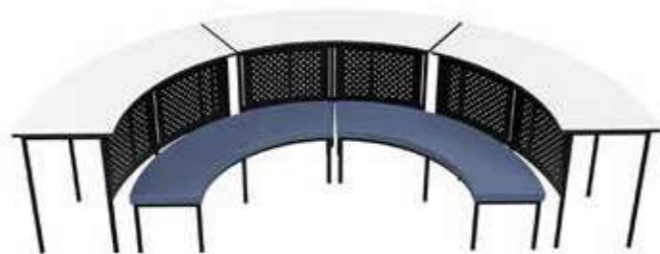

7 Year Warranty



Modular Design



Custom Options

The Santo Range provides ergonomic comfort with modern styling. Lounges feature thick memory foam padding with commercial grade upholstery fabric. Standard fabrics are available in select Spark colours and faux leather. To best suit your needs, custom fabrics are also available.



**Santo Chair**  
L600xD700x800mmH



**\$329**  
+GST (\$361.90)

Capacity, 6



**Get the look!**  
The Santo Booth brings a modern touch to school and office spaces.



**\$1,450**  
+GST (\$1,595.00)

**Santo Lounge**  
L1500xD700x800mmH



**\$599**  
+GST (\$658.90)

**Santo Booth**  
2 x Santo Lounge, 1 x Metro Meeting





# Bean Bags

# Storage

### Profile

L585xD710x810mmH, upholstered seat and backrest, replaceable seat and back panels, available with fabric or vinyl upholstery



Vinyl  
Fabric



From  
**\$219**  
+GST (\$240.90)

### Ottoman Bean Bag

L650xD550x350mmH, soft stretch cotton cover, stretchy polyester liner, child-resistant zippers on cover & liner, 12 month warranty on seams and zippers.



**\$159**  
+GST (\$174.90)

### 'S' Bean Bag

L1000xD800x400mmH, soft stretch cotton cover, stretchy polyester liner, child-resistant zippers on cover & liner, 12 month warranty on seams and zippers.



**\$189**  
+GST (\$207.90)

### Mini Moon Bean Bag

700DIAx600mmH, soft stretch cotton cover, stretchy polyester liner, child-resistant zippers on cover & liner, 12 month warranty on seams and zippers.



**\$219**  
+GST (\$240.90)

### Lounger Bean Bag

L900xD700x600mmH, soft stretch cotton cover, stretchy polyester liner, child-resistant zippers on cover & liner, 12 month warranty on seams and zippers.



**\$239**  
+GST (\$262.90)

### Pod Bean Bag

600DIAx1000mmH, soft stretch cotton cover, stretchy polyester liner, child-resistant zippers on cover & liner, 12 month warranty on seams and zippers.



**\$289**  
+GST (\$317.90)



### Anti-Vandal Locker 2 Door

H1840xW380xD455, padlock compatible, 1 x shelf per section, welded, heavy-duty locking system, reinforced doors, sloping tops and custom colours available.



**\$389**  
+GST (\$427.90)

### Anti-Vandal Locker 3 Door

H1840xW380xD455, padlock compatible, 1 x shelf per section, welded, heavy-duty locking system, reinforced doors, sloping tops and custom colours available.



**\$419**  
+GST (\$460.90)







- 7 Year Warranty
- Secure Storage
- Easy Clean
- Custom Options

Viking Lockers feature integrated ASSA ABLOY camlocks with padlock compatibility. Camlocks are durable and hard-wearing, making them ideal for high-use spaces.

Viking doors are designed to remain closed even when unlocked. Helping keep locker areas tidy throughout the day. Lockers feature a fully welded Australian Made frame for added strength. Locker doors are available in a wide range of colours and configurations.

### Additional Options

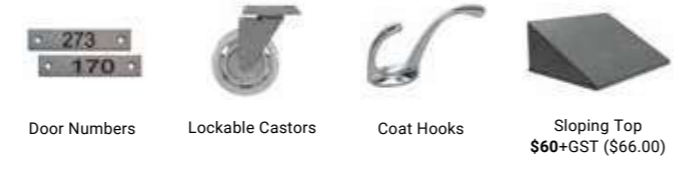

Door Numbers \$60+GST (\$66.00)



### Locker Door Colour Options



**Viking Half 2 Door**  
L720xD550x930mmH

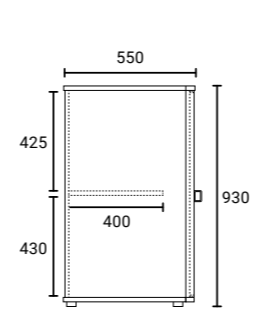

**Viking Half 3 Door**  
L1071xD550x930mmH



**Viking Half 4 Door**  
L1422xD550x930mmH

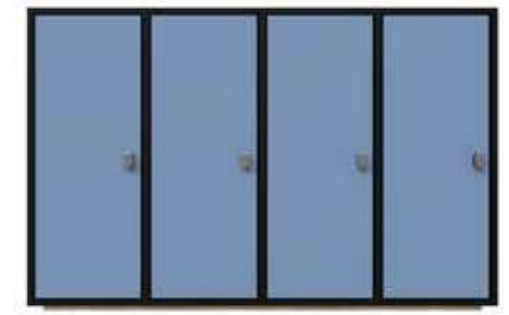

**\$449**  
+GST (\$493.90)

**\$579**  
+GST (\$636.90)

**\$729**  
+GST (\$801.90)

**Viking Intermediate 4 Door**  
L720xD550x1230mmH

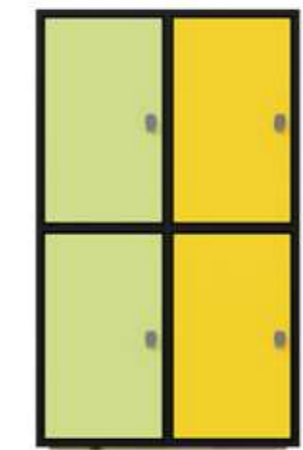
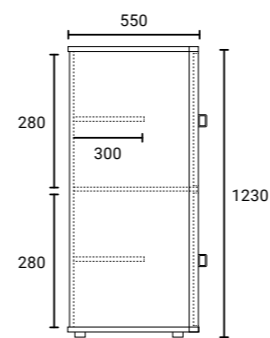

**Viking Intermediate 6 Door**  
L1071xD550x1230mmH

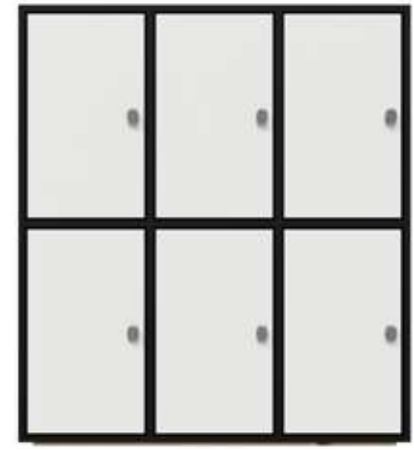

**\$639**  
+GST (\$702.90)

**\$799**  
+GST (\$878.90)

**Viking Full 4 Door**  
L720xD550x1825mmH

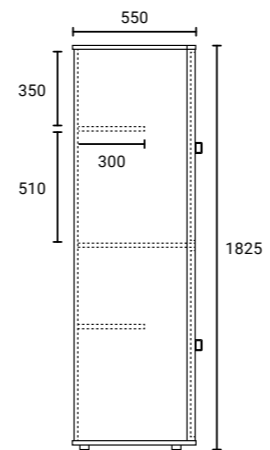

**Viking Full 6 Door**  
L720xD550x1825mmH

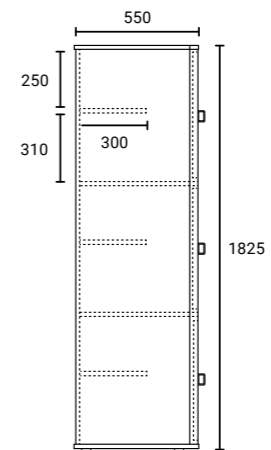

**\$759**  
+GST (\$834.90)

**\$879**  
+GST (\$966.90)



# Mobile Bag Units

# Mobile Bag Units



7 Year  
Warranty



Lockable  
Castors



Custom  
Options

Organise your classroom with Mobile Bag Units. Units feature spacious compartments for ample storage and accessibility. Lockable castors allow for easy mobility over both carpet and floorboards.

Bag units are available in Riverstone and Canadian Maple as standard. Optional tote boxes are available for added storage. Tote boxes provide quick access to high-use items such as textbooks, utensils and STEM supplies.



- Classrooms
- Library Areas
- STEM Spaces
- All Year Levels
- Storage Areas

## Mobile Bag Unit 4

Without Totes \$269+GST (\$295.90) With 4 Totes \$319+GST (\$350.90)

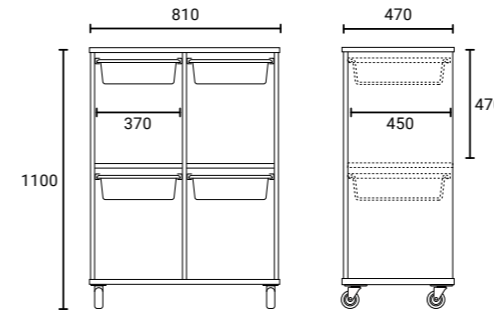

Without Totes  
**\$269**  
+GST (\$295.90)

With 4 Totes  
**\$319**  
+GST (\$350.90)

## Mobile Bag Unit 8

Without Totes \$369+GST (\$405.90) With 8 Totes \$469+GST (\$515.90)

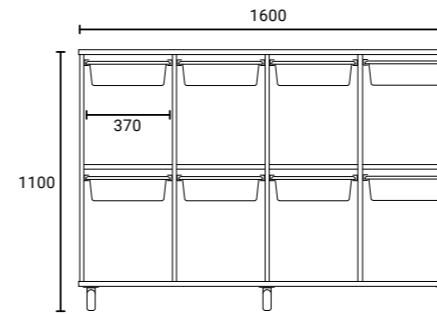

Without Totes  
**\$369**  
+GST (\$405.90)

With 8 Totes  
**\$469**  
+GST (\$515.90)

**Make it your own with custom options!**

### Schoolfurn Tote Boxes

L418xD362x105mmH, use with Mobile Bag Units, available in grey only.



**\$10**  
+GST (\$11.00)



Graphics shown include photographs, illustrations and 3D renders. 3D renders are for illustrative purposes only. Despite our best efforts, 3D renders may differ slightly from actual products.





- 7 Year  
Warranty
- Modular Design
- Australian  
Made
- Custom  
Options

Inspire a love for reading with Schoolfurn's library range. Library units feature lockable castors for easy mobility over carpet and floorboards. Bookcases are double sided for increased storage and functionality. Units are built to withstand heavy use within busy learning spaces.

Shelving units are modular to allow for creative layout options. Link multiple Curved Bookcases to create large snaking patterns. Similarly, create small reading retreats by using two or three curved units.



## Colour Options

- Arctic White
  - Elegant Oak\*
  - Seasoned Oak\*
  - Natural Oak\*
  - Custom\*
- \*Woodgrain finishes incur an additional cost of \$70+GST.  
\*See back page for custom colour options.

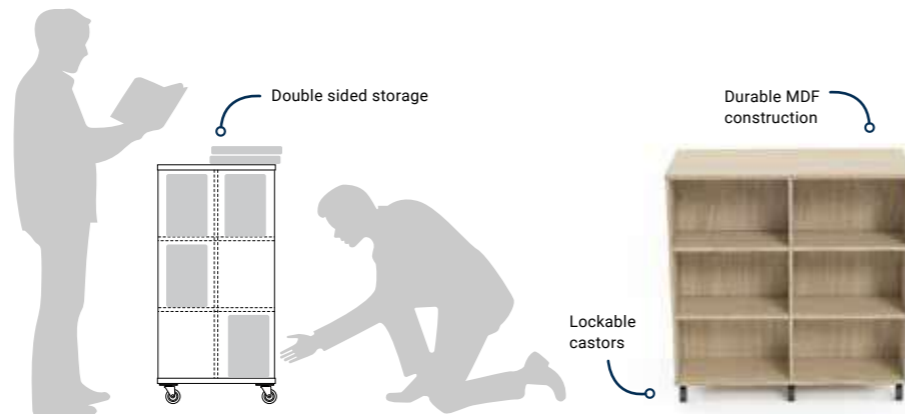

### Double Sided Bookcase 1200

L1200xD600x1200mmH

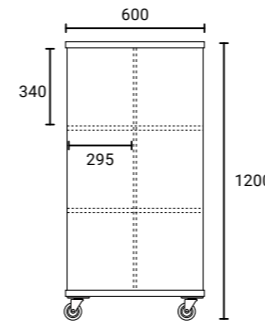

From  
**\$719**  
+GST (\$790.90)



From  
**\$829**  
+GST (\$911.90)

### Double Sided Bookcase Curved

L1377xD600x1200mmH

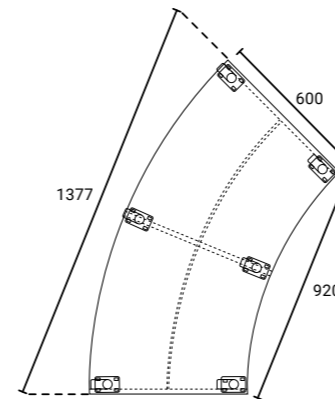

From  
**\$879**  
+GST (\$966.90)

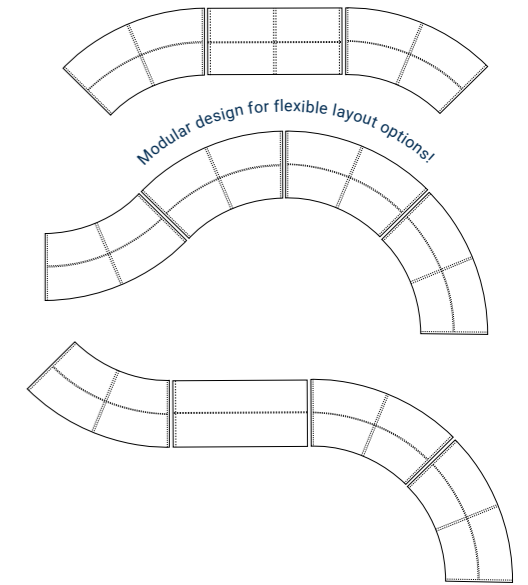

### Book Return

L500xD500x600mmH

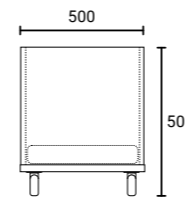

Internal Cushion



From  
**\$259**  
+GST (\$284.90)

### Book Display

L1100xD600x950mmH

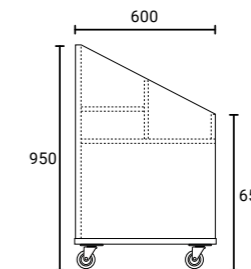

From  
**\$779**  
+GST (\$856.90)



# Tote Box Storage

**Ottomax Sit Store 6**  
L1092xD460x450mmH, 6 x SFX Totes, lockable castors.



**7 YEARS WARRANTY**

Vinyl

Spark

Body Colour

**\$525**  
+GST (\$577.50)

**Ottomax Sit Store 8**  
L1450xD460x450mmH, 8 x SFX Totes, lockable castors.



**7 YEARS WARRANTY**

Vinyl

Spark

Body Colour

**\$595**  
+GST (\$654.50)

**Tote Trolley 10**  
L758xD470x920mmH, MDF board, 10 x SFX Totes, lockable castors.  
Without Totes **\$339+GST** (\$372.90) With 10 Totes **\$439+GST** (\$482.90)



With 10 Totes  
**\$439**  
+GST (\$482.90)

**Tote Trolley 15**  
L1128xD470x920mmH, MDF board, 15 x SFX Totes, lockable castors.  
Without Totes **\$499+GST** (\$548.90) With 15 Totes **\$649+GST** (\$713.90)



With 15 Totes  
**\$649**  
+GST (\$713.90)

**Laminate Tote Trolley**  
L720xD460x1190mmH, 14 x SFX Totes, steel runners.



With Totes  
**\$675**  
+GST (\$742.50)

**Steel Tote Trolley 4 Tier**  
L1400xD450x790mmH, 4 tier, 16 x SFX Totes.  
Without Totes **\$565+GST** (\$621.50) With 16 Totes **\$725+GST** (\$797.50)



Without Totes  
**\$565+GST**

With 16 Totes  
**\$725**  
+GST (\$797.50)

**Steel Tote Trolley 5 Tier**  
L1400xD450x960mmH, 5 tier, 20 x SFX Totes.  
Without Totes **\$700+GST** (\$770.00) With 20 Totes **\$900+GST** (\$990.00)



Without Totes  
**\$700+GST**

With 20 Totes  
**\$900**  
+GST (\$990.00)

**Steel Tote Trolley 6 Tier**  
L1400xD450x1130mmH, 6 tier, 24 x SFX Totes.  
Without Totes **\$820+GST** (\$902.00) With 24 Totes **\$1,060+GST** (\$1,166.00)



Without Totes  
**\$820+GST**

With 24 Totes  
**\$1,060**  
+GST (\$1,166.00)

**Choose single colour totes or mix & match!**



**SFX Tote Box**  
L434xD325x130mmH, use with; Tote Trolley, Ottomax Sit Store, Laminate Tote Trolley, Steel Tote Trolley.  
Made from easy-clean durable plastic, available in 13 colours.

**\$10**  
+GST (\$11.00)



- White
- Yellow
- Sage
- Sky Blue
- Red
- Charcoal
- Orange
- Pine Lime
- Blue
- Burgundy
- Slate
- Green
- Black



# Display & Presentation

# Acoustic Wall Tiles

## Vertiface Pinboard

Pinnable surface, custom sizes available.

L900x600	\$140+GST (\$154.00)
L900x900	\$165+GST (\$181.50)
L1200x900	\$190+GST (\$209.00)
L1200x1200	\$210+GST (\$231.00)
L1500x900	\$260+GST (\$286.00)
L1500x1200	\$285+GST (\$313.50)
L1800x900	\$295+GST (\$324.90)
L1800x1200	\$320+GST (\$352.00)
L2100x900	\$395+GST (\$434.50)
L2100x1200	\$430+GST (\$473.00)
L2400x1200	\$455+GST (\$500.50)
L2700x900	\$419+GST (\$460.90)
L2700x1200	\$444+GST (\$488.40)
L3000x1200	\$565+GST (\$621.50)
L3600x1200	\$690+GST (\$759.00)



**10 YEARS WARRANTY** From **\$140** +GST (\$154.00)

## Porcelain Whiteboard

Wall mount whiteboards available in a wide range of sizes, custom sizes also available.

L900x600	\$129+GST (\$141.90)
L900x900	\$200+GST (\$220.00)
L1200x900	\$225+GST (\$247.50)
L1200x1200	\$268+GST (\$294.80)
L1500x900	\$316+GST (\$347.60)
L1500x1200	\$360+GST (\$396.00)
L1800x900	\$385+GST (\$423.50)
L1800x1200	\$410+GST (\$451.00)
L2100x900	\$432+GST (\$475.20)
L2100x1200	\$490+GST (\$539.00)
L2400x1200	\$580+GST (\$638.00)
L2700x1200	\$640+GST (\$704.00)
L3000x1200	\$675+GST (\$742.50)
L3600x1200	\$860+GST (\$946.00)



**15 YEARS WARRANTY** From **\$129** +GST (\$141.90)

## Hush Wall Tiles

L600xD600, 6 x tiles per pack (single colour), 1 pack covers 2.16 square meters, not velcro compatible, pinboard surface, peel off backing, non-toxic & non-irritant.



**3 YEARS WARRANTY** **\$99** +GST (\$108.90)

## Peel 'N' Stick Wall Tiles

L600xD600, 6 x tiles per pack (single colour), 1 pack covers 2.16 square meters, not velcro compatible, pinboard surface, peel off backing, non-toxic & non-irritant



**12 MONTHS WARRANTY** **\$249** +GST (\$273.90)

## Mobile Whiteboard

Double sided mobile whiteboards with porcelain or acrylic surfaces.

**Porcelain Surface;**

L1200x900	\$799+GST (\$878.90)
L1200x1200	\$959+GST (\$1,054.90)
L1500x900	\$1,039+GST (\$1,142.90)
L1500x1200	\$1,059+GST (\$1,164.90)
L1800x900	\$1,159+GST (\$1,274.90)
L1800x1200	\$1,259+GST (\$1,384.90)
L2100x1200	\$1,399+GST (\$1,538.90)

**Acrylic Surface;**

L1200x900	\$295+GST (\$324.50)
L1500x900	\$360+GST (\$396.00)
L1500x1200	\$390+GST (\$429.00)
L1800x1200	\$450+GST (\$495.00)



**15 YEARS WARRANTY** From **\$295** +GST (\$324.50)

## Teach-Rite Mobile Porcelain Whiteboard

L1800x1000, lockable castors, pen tray, porcelain whiteboard surface, double sided, high performance and durability.



**10 YEARS WARRANTY** **\$695** +GST (\$764.50)

## Hex Wall Tiles

L312xW360x9mmH, 6 x tiles per pack (single colour), peel off backing, pinnable surface, made from 60% recycled material, strong adhesive backing that sticks to most surfaces.



**3 YEARS WARRANTY** **\$49** +GST (\$53.90)



## Vision Teacher Station

L900xD600x1050mmH, large work surface, internal storage with shelf, 2 x drawers, 1 x pullout work surface, 1 x cupboard, designed for standing and seated use, soft close runners.



**5 YEARS WARRANTY** **\$499** +GST (\$548.90)

## Mobile Literacy Unit

L830xD415x1520mmH, lockable castors, adjustable front shelf, pen tray and paper gripper, porcelain whiteboard surface, front and back book storage.



**7 YEARS WARRANTY** **\$499** +GST (\$548.90)

## Freestanding Partition

H1200   1500   1800 x W900	\$230+GST (\$253.00)	H1200   1500   1800 x W1200	\$280+GST (\$308.00)
H1200   1500   1800 x W15000	\$330+GST (\$363.00)	H1200 x W1800	\$280+GST (\$308.00)
H1500 x W1800	\$380+GST (\$418.00)	H1800 x W1800	\$390+GST (\$429.00)



**5 YEARS WARRANTY** From **\$230** +GST (\$253.00)



**Get the look!** Use castors for flexible layout options. Add lockable castors for **\$50+GST (\$55.00)**.



**Sprinta**  
Ergonomic controls, 2 colour options, ideal for teachers and office spaces.



**3 YEARS WARRANTY**

**\$129**  
+GST (\$141.90)

**Endura**  
Australian Made, ergonomic controls, height adjustable gas lift.



**5 YEARS WARRANTY**

**\$159**  
+GST (\$174.90)

**Endura Deluxe**  
Australian Made, memory foam seat, adjustable seat and back controls.



**5 YEARS WARRANTY**

**\$179**  
+GST (\$196.90)

**Zone**  
Mesh backrest, ergonomic controls, armrests, black fabric upholstery and PU components.



**NEW!**

**5 YEARS WARRANTY**

**\$219**  
+GST (\$240.90)

**Hilton MB**  
Black PU upholstery, gas lift, tilt lock mechanism, upright armrests included.



**5 YEARS WARRANTY**

**\$239**  
+GST (\$262.90)

**Hula Black**  
Korean 3D mesh, height adjustable lumbar support, PU 3D armrest, adjustable seat depth, polished aluminium base.



**NEW!**

**5 YEARS WARRANTY BIFMA**

**\$349**  
+GST (\$383.90)

**Barwon Mesh**  
Mesh backrest, fully ergonomic controls, lift rated to 180KG, black fabric upholstery.



**NEW!**

**5 YEARS WARRANTY**

**\$189**  
+GST (\$207.90)

**Versa**  
Thick foam seat, 3/4 back height, adjustable seat and backrest controls.



Armrest Model \$239.00+GST

From **\$229**  
+GST (\$251.90)

**Versa Deluxe**  
Ideal for heavy use, 3/4 back height, adjustable seat and backrest controls.



Armrest Model \$259.00+GST

From **\$339**  
+GST (\$372.90)

**Hula White**  
Korean 3D mesh, height adjustable lumbar support, PU 3D armrest, adjustable seat depth, white base and armrests.



**NEW!**

**5 YEARS WARRANTY BIFMA**

**\$369**  
+GST (\$383.90)

**Boston MB**  
Polished chrome base, adjustable lumbar support, PU 3D armrest, adjustable seat depth, black PU upholstery.



**5 YEARS WARRANTY**

**\$389**  
+GST (\$427.90)

**Boston HB**  
Ultra comfortable, black PU upholstery, adjustable gas lift, tall backrest for added back and lumbar support.



**5 YEARS WARRANTY**

**\$399**  
+GST (\$438.90)

**Aria**  
Mesh backrest, fabric seat, height adjustable gas lift, ergonomic controls.



Armrest Model \$309.00+GST

From **\$259**  
+GST (\$284.90)

**Omega**  
Heavy-duty design, thick foam padding, ergonomic controls, height adjustable gas lift.



Armrest Model \$279.00+GST

From **\$229**  
+GST (\$251.90)

**Ergoform**  
Seat slider, AFRDI rated, ideal for high use spaces.



Armrest Model \$339.00+GST

**5 YEARS WARRANTY AFRDI**

From **\$339**  
+GST (\$372.90)

**Endeavour**  
Heavy duty design, full ergonomic controls, leather available for \$479+GST.



**5 YEARS WARRANTY BIFMA**

**\$399**  
+GST (\$438.90)

**Volt**  
Modern duty design, ideal for board rooms, 4 colour options.



**5 YEARS WARRANTY**

**\$419**  
+GST (\$460.90)

**Seville HB**  
AFRDI load rated, adjustable seat slider, mesh backrest. Armrests included.



**7 YEARS WARRANTY AFRDI**

**\$439**  
+GST (\$482.90)

**Lumbarsoft**  
Added lumbar support, thick foam padding, fabric upholstery.



Armrest Model \$339.00+GST

From **\$279**  
+GST (\$306.90)

**Siena Medium Back**  
Adjustable backrest, adjustable lumbar support, weight activated synchro mechanism.



Armrest Model \$399.00+GST

From **\$349**  
+GST (\$383.90)

**Ergo-Air**  
Air controlled lumbar support, memory foam padding, available in 3 colour options.



Armrest Model \$409.00+GST

From **\$359**  
+GST (\$394.90)

**Ergo Stool PU**  
Height range 400 to 530mmH, circular gas lift control, easy-clean surface.



**5 YEARS WARRANTY**

**\$119**  
+GST (\$130.90)

**Ergo Stool Vinyl**  
Height range 420 to 550mmH, easy glide castors, vinyl seat upholstery, chrome and black frame.



**5 YEARS WARRANTY**

**\$139**  
+GST (\$152.90)

**Cad Stool**  
Height range 530 to 640mmH, adjustable controls, ergonomic saddle seat, optional drafting kit.



Drafting Kit \$289.00+GST

From **\$209**  
+GST (\$229.90)

Graphics shown include photographs, illustrations and 3D renders. 3D renders are for illustrative purposes only. Despite our best efforts, 3D renders may differ slightly from actual products.



**Aero**  
Plastic seat and backrest, chrome sled frame, protective feet, stackable design.



**10 YEARS WARRANTY**

From **\$79**  
+GST (\$86.90)

**Active**  
Stackable, upholstered seat, ergonomic backrest with carry handle, plastic linkable feet, black sled frame.



**7 YEARS WARRANTY**

**\$99**  
+GST (\$108.90)

**Neo**  
Stackable, mesh backrest, padded seat, black fabric only.



**3 YEARS WARRANTY**

**\$115**  
+GST (\$126.50)

**Rod**  
Stackable, rounded backrest, chrome sled frame, 3 fabric colour options, available in black PU leather.



**3 YEARS WARRANTY**

**\$129**  
+GST (\$141.90)

**Jackson**  
Black fabric, rounded backrest, black powder coat metal frame.



Armrest Model  
**\$190.00+GST**

From **\$170**  
+GST (\$187.00)

**Spencer**  
Mesh backrest with fabric seat, stackable and linkable frame, 5 fabric colour options.



**5 YEARS WARRANTY**

**\$175**  
+GST (\$192.50)

**NEW!**  
**Sunny**  
Fabric upholstery with top stitch detail, chrome sled frame, protective feet.



**5 YEARS WARRANTY**

**\$159**  
+GST (\$174.90)

**Nikola Sled**  
White or black sled frame, stitch detail, 6 fabric colour options.



Armrest Model  
**\$299.00+GST**

From **\$225**  
+GST (\$247.90)

**Leo**  
Large tub seat, curved back and armrests, PU leather upholstery.



**5 YEARS WARRANTY**

**\$319**  
+GST (\$350.90)

**Orion Tub**  
Rounded tub, black PU leather, ideal for reception spaces.



**5 YEARS WARRANTY**

**\$349**  
+GST (\$383.90)

**NEW!**  
**Snow**  
Modern timber frame, wide seat, fabric upholstery, thick foam padding.



Without Armrest  
**\$370.00+GST**

From **\$390**  
+GST (\$429.00)

**Eadu**  
Bold modern design, geometric shape, black wire frame, plastic protective feet.



**5 YEARS WARRANTY**

**\$795**  
+GST (\$874.50)

**Oprah Range**  
Geometric design, angled back and armrests, fabric upholstery, comfortable tub seat, timber or metal frame options, available in charcoal fabric or custom upholstery.



Metal Sled Frame **\$425+GST** (\$467.50)  
Eco Timber Frame **\$465+GST** (\$511.50)

**NEW!**

**5 YEARS WARRANTY**

From **\$425**  
+GST (\$467.50)

**Tulip Range**  
Contemporary design, fabric upholstery, curved arms and back, mid-height backrest, thick foam padding, timber or metal frame options.



Eco Timber Frame **\$569+GST** (\$625.90)  
Metal Sled Frame **\$599+GST** (\$658.90)

**5 YEARS WARRANTY**

From **\$569**  
+GST (\$625.90)

**Velcro Lounge Range**  
Black PU upholstery, robust stainless steel frame, hardwood substrate for added durability.



Single Seater **\$475+GST** (\$522.40)  
Twin Seater **\$825+GST** (\$907.50)

**5 YEARS WARRANTY**

Twin Seater **\$825.00+GST**

Single Seater **\$475.00+GST**

From **\$475**  
+GST (\$522.50)

**Milano Lounge Range**  
Leather upholstery, stainless steel profile frame.



Single Seater **\$675+GST** (\$742.50)  
Twin Seater **\$995+GST** (\$1,094.50)  
Three Seater **\$1,355+GST** (\$1,490.50)

**7 YEARS WARRANTY**

Twin Seater **\$995.00+GST**

Single Seater **\$675.00+GST**

From **\$675**  
+GST (\$742.50)

**Rivet Lounge**  
Solid timber inner frame, black PU leather upholstery, stainless steel frame with armrests.



Single Lounge **\$349+GST** (\$383.90)  
Twin Lounge **\$579+GST** (\$636.90)

**5 YEARS WARRANTY**

Twin Seater **\$579.00+GST**

Single Seater **\$349.00+GST**

From **\$349**  
+GST (\$383.90)

**Venice Lounge**  
Modern curved armrests, steel zigzag legs, mid-height backrest.



Single Seater **\$540+GST** (\$594.00)  
Twin Seater **\$650+GST** (\$715.00)  
Three Seater **\$850+GST** (\$935.00)

**5 YEARS WARRANTY**

Twin Seater **\$650.00+GST**

Single Seater **\$540.00+GST**

From **\$540**  
+GST (\$594.00)



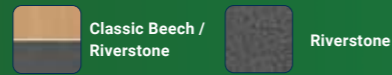

**Nevada Fixed Drawer**  
L465xD447x454mmH, 1 x Personal, 1 x File Drawer, lockable



**\$110**  
+GST (\$121.00)

**Nevada Mobile 3 Drawer**  
L400xD510x675mmH, 2 x Personal, 1 x File Drawer, lockable



**\$180**  
+GST (\$198.00)

**Nevada Mobile 4 Drawer**  
L400xD510x675mmH, 4 x Personal Drawer, lockable



**\$190**  
+GST (\$209.00)

**Nevada Package A**  
Desk Size Options; L1350x750, L1500x750  
1 x Nevada Fixed Drawer



**\$280**  
+GST (\$308.00)

**Nevada Package B**  
Desk Size Options; L1350x750, L1500x750  
1 x Nevada Mobile Drawer



**\$320**  
+GST (\$352.00)

**Nevada Package C**  
Desk Size Options; L1350x750, L1500x750  
1 x Nevada Fixed Drawer  
1 x Sprinta Chair



**\$399**  
+GST (\$438.90)

**Nevada Desk Return**  
L900xD600x730mmH



**\$110**  
+GST (\$121.00)

**Nevada Desk**  
L1350xD750x730mmH **\$190**+GST (\$209.00)  
L1500xD750x730mmH **\$190**+GST (\$209.00)  
L1800xD750x730mmH **\$200**+GST (\$220.00)



**From \$190**  
+GST (\$209.00)

**Nevada Hutch**  
L1350xD300x1080mmH, L1500xD300x1080mmH,  
L1800xD300x1080mmH



**\$220**  
+GST (\$242.00)

**Nevada Package D**  
Desk Size Options; L1350x750, L1500x750  
1 x Nevada Mobile Drawer  
1 x Sprinta Chair



**\$439**  
+GST (\$482.90)

**Nevada Package E**  
Desk Size Options; L1350x750, L1500x750  
1 x Nevada Fixed Drawer  
1 x Nevada Hutch



**\$480**  
+GST (\$528.00)

**Nevada Package F**  
Desk Size Options; L1350x750, L1500x750  
1 x Nevada Mobile Drawer  
1 x Nevada Hutch



**\$520**  
+GST (\$572.00)

**Nevada Bookcase 1200**  
1200mmHxL900xD320



**\$199**  
+GST (\$218.90)

**Nevada Bookcase 1800**  
1800mmHxL900xD320



**\$219**  
+GST (\$240.90)

**Nevada Cupboard**  
1800mmHxL900xD450, 4 adjustable shelves, lockable,  
silver tone handles



**\$379**  
+GST (\$416.90)

**Nevada Package G**  
Desk Size Options; L1350x750, L1500x750  
1 x Nevada Fixed Drawer  
1 x Sprinta Chair  
1 x Nevada Hutch



**\$599**  
+GST (\$658.90)

**Nevada Package H**  
Desk Size Options; L1350x750, L1500x750  
1 x Nevada Mobile Drawer  
1 x Sprinta Chair  
1 x Nevada Hutch



**\$639**  
+GST (\$702.90)

**Nevada Round**  
4 or 5 way frame, black or chrome frame finish.  
900DIA **\$190**+GST (\$209.00)  
1200DIA **\$220**+GST (\$242.00)



**From \$190**  
+GST (\$209.00)





Natural Oak /  
Natural White



Natural White

**Montana Desk**  
L1500xD750x730mmH



**\$220**  
+GST (\$209.00)

**Montana Mobile 3 Drawer**  
L400xD510x675mmH, 2 x Personal Drawer, 1 x File Drawer



**\$180**  
+GST (\$198.00)

**Montana Hutch**  
L1500xD300x1080mmH



**\$220**  
+GST (\$242.00)

**Montana Bronze Package**  
1 x Montana Desk (L1500x750), 1 x Montana Mobile 3 Drawer



**\$390**  
+GST (\$429.00)

**Montana Silver Package**  
1 x Montana Desk (L1500x750), 1 x Montana Mobile 3 Drawer, 1 x Zone Chair



**\$599**  
+GST (\$658.90)

**Montana Disc Meeting Table**  
900DIAx755mmH \$259+GST (\$284.90)  
1200DIAx755mmH \$299+GST (\$328.90)



From  
**\$259**  
+GST (\$284.90)

**Montana 4 Leg Meeting Table**  
900DIAx755mmH \$319+GST (\$350.90)  
1200DIAx755mmH \$359+GST (\$394.90)



From  
**\$319**  
+GST (\$350.90)

**Montana Boardroom Table**  
L1800xD900 \$395+GST (\$434.50)  
L2400xD1200 \$565+GST (\$621.50)



From  
**\$395**  
+GST (\$434.50)

**Montana Gold Package**  
1 x Montana Desk (L1500x750), 1 x Montana Mobile 3 Drawer, 1 x Montana Hutch



**\$590**  
+GST (\$649.00)

**Montana Platinum Package**  
1 x Montana Desk (L1500x750), 1 x Montana Mobile 3 Drawer, 1 x Montana Hutch, 1 x Zone Chair



**\$799**  
+GST (\$878.90)

**Montana Disc Coffee Table**  
600DIAx425mmH



**\$180**  
+GST (\$198.00)

**Montana 4 Leg Coffee Table**  
L1200xD600x450mmH



**\$260**  
+GST (\$286.00)

**Montana Cupboard**  
1800mmHxL900xD450, 4 adjustable shelves, lockable, silver tone handles



**\$379**  
+GST (\$416.90)

Custom colours available. Contact our sales team to learn more.

1300 800 957  
sales@schoolfurn.com.au

Montana Gold Package in Canadian Maple, Riverstone and silver powder coat frame.

- McKinnon Secondary College





# Electric Workstations

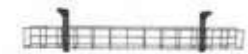

**Vertilift Single Cable Tray**  
From \$20+GST (\$22.00)

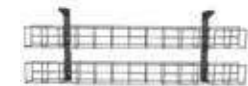

**Vertilift Double Cable Tray**  
From \$35+GST (\$38.50)

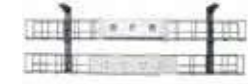

**Vertilift Cable Tray With Power**  
From \$105+GST (\$115.50)



**Modesty Panel**  
From \$60+GST (\$66.00)



Height Adjustable



Lift Capacity



AFRDI Accredited



Anti-Collision Technology

Electric workstations are height adjustable allowing for both standing and seated use. Desks feature quiet, dual motors, providing smooth and controlled adjustment. Electric tables continue to be a popular option for school, home and office environments.

- Work
- Home Office
- Back Pain
- STEM Spaces

# Boardroom Tables

## Supreme Table

25mm table top, 2mm protective ABS edge banding, twin pedestal chrome frame, adjustable feet, under table power and data mount compatible. Table tops available with a rectangular or shaped top. Custom options also available.

Rectangular		Shaped	
L1800xD900	\$595+GST (\$654.50)	L1800xD900	\$685+GST (\$753.50)
L2100xD1050	\$670+GST (\$737.00)	L2100xD1050	\$815+GST (\$896.50)
L2400xD1200	\$750+GST (\$826.00)	L2400xD1200	\$850+GST (\$935.00)
L3600xD1200	\$1,190+GST (\$1,309.00)	L3600xD1200	\$1,430+GST (\$1,573.00)



Rectangular Boat D-End Oval



From **\$595**  
+GST (\$654.50)



## EduLift Desk

Twin motor, 125kg lift power, under desk controller, available 6 standard colours, custom options available, black or white frame available.

L1500xD750	\$879+GST (\$966.90)
L1800xD750	\$899+GST (\$988.90)



From **\$879**  
+GST (\$966.90)

## EduLift Workstation

L1800xD1800, triple motor, 125kg lift power, available 6 standard colours, custom options available, black or white frame available.



From **\$1,399**  
+GST (\$1,538.90)

## Delta Table

25mm rectangular table top, 2mm protective ABS edge banding, black powder coat frame as standard, chrome frame options available.

L1800xD900	\$565+GST (\$621.50)
L2100xD1050	\$695+GST (\$764.00)
L2400xD1200	\$945+GST (\$1,039.50)
L3600xD1200	\$1,225+GST (\$1,347.50)



From **\$565**  
+GST (\$621.50)



## Hercules Teacher

L1200xD600, fully welded steel frame, black powder coat, perforated steel modesty panel, 18mm table top, available in 14 table top colours, custom options available.



**\$185**  
+GST (\$203.50)

## Hercules Teacher Package

1 x Hercules Teacher, 1 x Movida 3 Drawer Pedestal



**\$380**  
+GST (\$418.00)

## Toro Table

25mm rectangular table top, 2mm protective ABS edge banding, durable steel legs, black powder coat frame.

L1800xD900	\$695+GST (\$764.50)
L2400xD1200	\$795+GST (\$874.50)
L3600xD1200	\$1,195+GST (\$1,314.50)



From **\$695**  
+GST (\$764.50)





### Outliner Desk with Return

Sharknose edge, 25mm Construction, cable entry hole included, shadow line detail.  
 L1800xD900 with 900 return **\$1,235+GST** (\$1,358.50)  
 L2100xD900 with 1200 return **\$1,345+GST** (\$1,479.50)



From **\$1,235**  
+GST (\$1,358.50)

### Vista Lite with Return

L2100xD900 with 1200 return, asymmetrical design, frame available in Black or White, 25mm table top, cable entry hole included, integrated modesty panel.

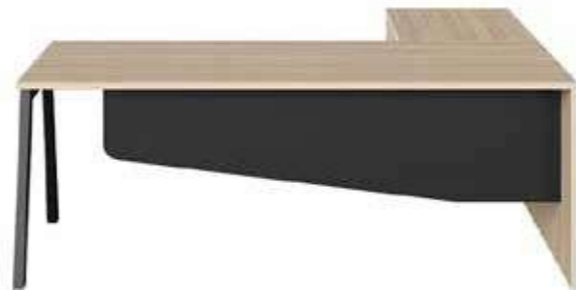

**\$1,425**  
+GST (\$1,567.50)

### Rapid Desk

Built in modesty panel, steel frame, easy-clean laminate surface.  
 L1200xD700 **\$235+GST** (\$258.50)  
 L1500xD700 **\$249+GST** (\$273.90)  
 L1800xD700 **\$269+GST** (\$295.90)



From **\$235**  
+GST (\$258.50)



### Rapid Workstation

Built in modesty panel, steel frame, easy-clean laminate top, ample workspace.  
 L1500xD1500 **\$429+GST** (\$471.90)  
 L1800xD1800 **\$449+GST** (\$493.90)



From **\$429**  
+GST (\$471.90)

### Geo Slab End Desk with Return

Table top cable entry, shadow lines on desk return undercarriage, custom options.  
 L2100xD900 with 900 return **\$1,545+GST** (\$1,699.50)  
 L2400xD900 with 1200 return **\$1,695+GST** (\$1,864.50)



From **\$1,545**  
+GST (\$1,699.50)

## Extended Range Online



See our full range of designer storage, buffet and desking solutions. *Contact us for a free onsite measure and quote!*

P. 1300 800 957 E. sales@schoolfurn.com.au

### Rapid Mobile Pedestal

L465xD450x690mmH, 2 x Personal, 1 x File, lockable design, metal pull handles, mobile castors.



**\$225**  
+GST (\$247.50)



### Movida Steel Pedestal

L390xD520x600mmH, 2 x Personal, 1 x File, lockable design, steel construction, mobile castors.



**\$199**  
+GST (\$218.90)

### Rapid Buffet

Dual sliding doors, lockable with key, metal pull handles, 1 x internal shelf, available in 2 sizes.  
 L1200xD450x730mmH **\$299+GST** (\$328.90)  
 L1800xD450x730mmH **\$399+GST** (\$438.90)



From **\$299**  
+GST (\$328.90)

### Go Steel Filing Cabinet

2 Drawer Filing Cabinet 705mmHxL460xD620 **\$269+GST** (\$295.90)  
 3 Drawer Filing Cabinet 1060mmHxL460xD620 **\$309+GST** (\$339.90)  
 4 Drawer Filing Cabinet 1321mmHxL460xD620 **\$349+GST** (\$383.90)



2 Drawer

3 Drawer

4 Drawer



From **\$269**  
+GST (\$295.90)

### Go Cupboard

1015mmHxL910xD450 **\$289+GST** (\$317.90)  
 1830mmHxL910xD450 **\$345+GST** (\$379.90)  
 2000mmHxL910xD450 **\$430+GST** (\$473.00)



From **\$289**  
+GST (\$317.90)

### Rapid Cupboard

1800mmHxL900xD450, adjustable shelves, lockable.



**\$475**  
+GST (\$522.50)

### Rapid Bookcase

Adjustable shelves, MDF board.  
 1200mmHxL900xD315 **\$225+GST** (\$247.50)  
 1800mmHxL900xD315 **\$265+GST** (\$291.50)



**\$225**  
+GST (\$247.50)

### Deluxe Bookcase

25mm adjustable shelves, steel legs, ABS edge banding.  
 1200mmHxL900xD315 **\$299+GST** (\$328.90)  
 1800mmHxL900xD315 **\$349+GST** (\$383.90)



**\$299**  
+GST (\$328.90)

Graphics shown include photographs, illustrations and 3D renders. 3D renders are for illustrative purposes only. Despite our best efforts, 3D renders may differ slightly from actual products.



# Colour Options

Choose from our wide range of upholstery fabrics, vinyl options and table top colours. Fabric options are available for chairs and soft furnishings and incur no additional cost. Through our supply partners, custom colours and fabrics are also available. Custom options do incur additional cost and may require a minimal order quantity. Contact your sales representative to learn more.

## Zed & Squirrel® Colour Range



Aqua Lime Green Tangerine Blue Galaxy Charcoal

## i-Sit Colour Range

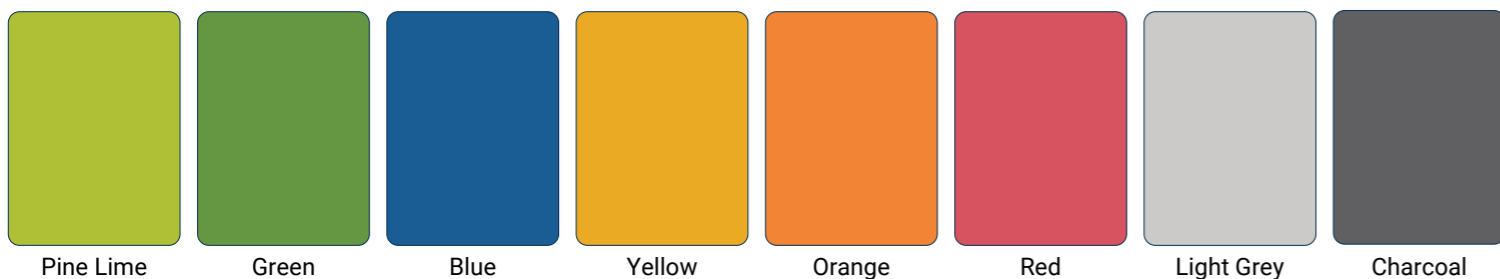

Pine Lime Green Blue Yellow Orange Red Light Grey Charcoal

## Santo Range



Moss / Storm Lagoon / Storm Flame / Storm Eggplant / Storm PU Faux Leather

## Quad Fabric Range

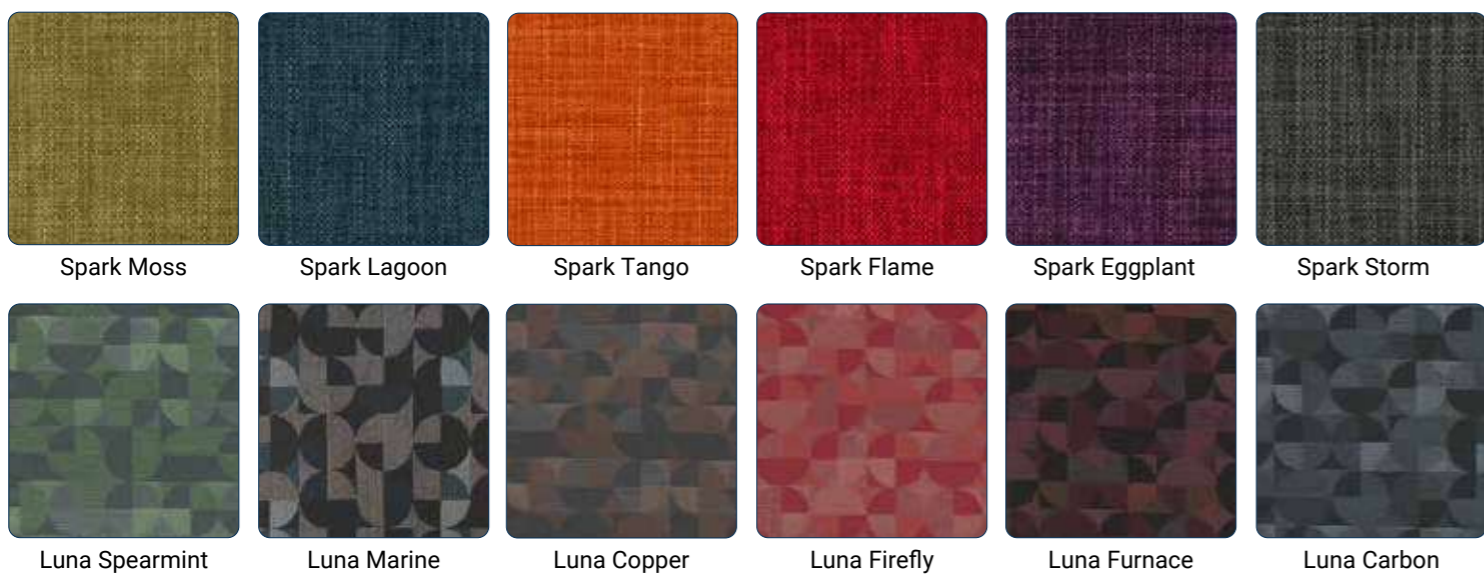

Spark Moss Spark Lagoon Spark Tango Spark Flame Spark Eggplant Spark Storm  
Luna Spearmint Luna Marine Luna Copper Luna Firefly Luna Furnace Luna Carbon

# Colour Options

## Standard Fabric Range

• Aero • Lumbarsoft • Ottomax Range  
• Omega • Versa Range • Endura Range



Spark Moss Spark Lagoon Spark Tango Spark Flame Spark Eggplant Spark Storm House Navy House Black

## Standard Vinyl Range

• Quad Range  
• Ottomax Range



Apple Marine Sunset Chilli Plum Charcoal

## Standard Table Top Range

• Height Adjustable Tables • Hercules Table Range  
• Fixed Height Tables • Viking Locking Doors



Whiteboard\* Arctic White Apple Green Primary Green China Blue Primary Blue Yellow Orange  
Primary Red Canadian Maple Classic Beech Natural Oak Brushed Silver Diamante Riverstone Custom\*

### Replacement Table Tops

Replacement tops are an easy and affordable way to extend the life of your tables. Tops are available in our full colour range including 18 and 25mm board.



Need something different? We offer custom table tops tailored to your needs. Contact us to learn more!

### Rectangular

L1200xD600, custom sizes available.



From **\$39**  
+GST (\$42.90)

### Round

1200DIA, custom sizes available.



From **\$85**  
+GST (\$93.50)

Due to printing fluctuations colour swatches may differ slightly. Swatch samples should be used for true likeness. Contact us to arrange colour samples.  
\*Whiteboard surfaces and custom colours may incur additional costs and be subject to minimum order quantities.

## Commercial Table Top Range



- Conferencing Tables
- Breakout Tables
- Library Range
- Office Tables
- Office Workstations



White



Seasoned Oak



Select Beech



Elegant Oak



Natural Oak

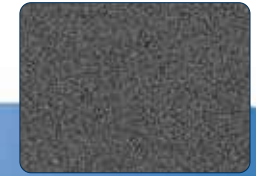

Riverstone

## Extended Table Top Range



Custom colour icon indicates products available in our extended table top colour range.

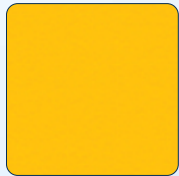

Olympia Yellow

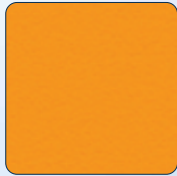

Mandarin



Juicy



Olympia Blue



Pillar Box Red



Polar White

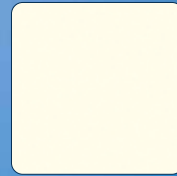

Parchment



Oyster Grey

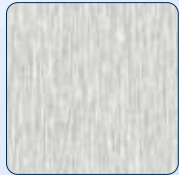

Zinc Works



Soft Walnut



Fox Teakwood

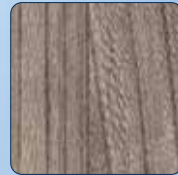

Lustrous Elm



Alaskan



Raw Birchply



Oyster Linea



Milkwood

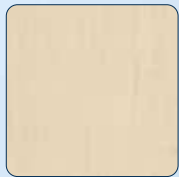

Dansk Maple



Rock Maple



Curly Birch



Young Beech



Sublime Teak



Silver Ash



Maison Oak

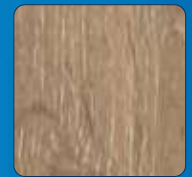

Rural Oak



Natural Walnut



Jarrah Legno

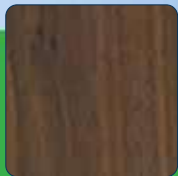

Milano Walnut



Licorice Linea



Burnished Wood



Charcoal



Battalion



Black

## Contact Us

**Gary Rickards**  
Sales Manager

M. 0428 031 853  
E. gary@schoolfurn.com.au

**Adam Scott**  
Director

M. 0417 556 560  
E. adam@schoolfurn.com.au

**Ken Biggs**  
Sales Manager

M. 0474 168 920  
E. ken@schoolfurn.com.au



1300 800 957



www.schoolfurn.com.au



sales@schoolfurn.com.au



51-57 Gilbert Park Drive, Knoxfield, VIC 3180